

# MXG2ARTR

3.5" MX G2 LED Adjustable

JOB NAME		CATALOG NUMBER	
NOTES		TYPE	

## ELECTRICAL DATA

LED Light Engine	System Wattage *	CCT / CRI	Delivered Lumens **	Lumens Per Watt
L0	10W	3000K / 82 CRI	950lm	95
L1	16W	3000K / 82 CRI	1300lm	81
L2	20W	3000K / 82 CRI	1550lm	78
L3	26W	3000K / 82 CRI	1850lm	71

\*System Wattage include driver and LED Module consumption. \*\*Delivered lumens will vary depending on trim, CCT, CRI, optic and ceiling thickness

## FEATURES

- Multiple architectural trim options
- High center beam spot up to 24,500 CBCP
- Dedicated 9° with field changeable 12°, 24°, 36° & 50° optics

## LED LIGHT ENGINE

- 92 CRI & 82 CRI in 2700K, 3000K, 3500K or 4100K with ZSDCM binning
- >50,000 hours L70 (rated life at 70% output)

## ELECTRICAL SYSTEM

- (Non-IC) Dedicated voltage options of 120V or 277V. Must be specified in catalog code.
- (-IC/-CP) Universal 120V/277V input
- This product complies with IEEE C62.41 for surge endurance up to 2.5KV. Additional surge protection recommended. Damage from power surge is not covered by warranty.

## DIMMING

- 0-10V Dimming 1%
- Forward/reverse dimming 1% (120V only)
- EldoLED 0-10V 0.1% or 1%
- Lutron® LDE1 Hi-Lume 1% EcoSystem LED driver with Soft-on, Fade-to-Black dimming technology
- Lutron® LTEA2W Hi-Lume 1% 2-Wire LED driver (120V forward phase only)
- DMX512 RDM 0.1%

## HOUSING

- Heavy duty black powder coated 18 gauge steel frame
- Standard housing accommodates 5/8" ceiling thickness
- Extended collar options available for ceilings up to 1" or 2" thick, must specify either EC1 or EC2 (EC1/EC2 Not available with Chicago Plenum)

## TRIM SPECIFICATION

Aiming with locking 35° vertical and 360° horizontal adjustment. High quality trims are die-cast using A380 aluminum with durable powder coat available in multiple finishes. Architectural, discrete self flange or painted white flange options available. Trims available in 1" regress for greater visual comfort or 1/2" regress for consistent look throughout space.

## INSTALLATION

Housing types include IC Air-Tight, CCEA (Chicago Plenum), or Non-IC Rated (must specify). Non-IC rated housings must be kept at a minimum of 3" away from insulation. Butterfly brackets are compatible with C-channel, adjustable bar hangers (14"-25") and EMT. C-channel is recommended for T-bar ceilings. Bar hangers must be ordered separately. Max. ambient temperature: 95°F (35°C).

## ACCESSORIES

Luminaire will accommodate (2) accessories, accessory holder required, see page 2.

## EMERGENCY BACKUP

Remote test switch included. External battery operates LED load at a minimum of 500 to 850 lumens for 90 minutes, depending on backup wattage selected. See trim multipliers for detailed performance. Servicing requires above ceiling access. (EM not available with Chicago Plenum)

## LISTING / WARRANTY

- 5-Year Intense LED Limited Warranty
- ETL listed to US and Canadian standards for damp locations
- (-IC/-CP Only) Air-Tight Certified ASTM E283
- (-IC/-CP Only) ETL Listed for direct contact w/insulation
- (-CP Only) CCEA Chicago Plenum
- ENERGY STAR® Qualified <sup>1</sup>
- Can be used to comply with 2016 Title 24, Part 6, JAB high efficacy LED light source requirements <sup>2</sup>

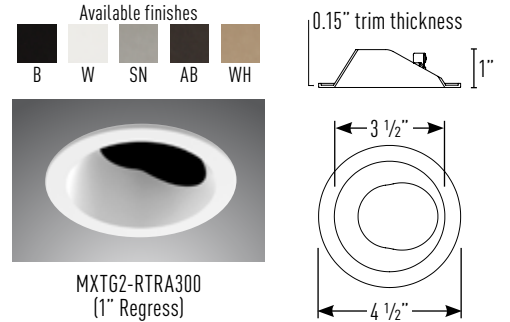

MXTG2-RTRA300  
(1" Regress)

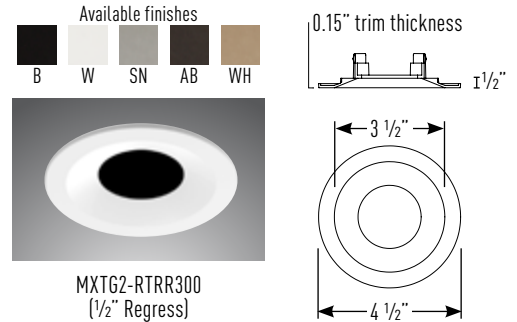

MXTG2-RTRR300  
(1/2" Regress)

Housing dimensions are on Page 2

## Housing Part Number (Example: MXG2ARTR-ICL1)

Housing	Installation Type	Ceiling Thickness	Wattage	Dimming	Voltage	Options
MXG2ARTR	-NC (Non-IC)	blank (5/8")	L0 (10W)	blank (Non-Dimming)	blank (Non-IC: 120V	1100 (C-Channel Bar Hangers)
	-IC (Air-Tight IC)	EC1 <sup>3</sup> (1")	L1 (16W)	DELV <sup>5</sup> (Phase Dimming)	-IC/-CP: 120V/277V)	1200 (Flat Bar Hangers)
	-CP (Chicago Plenum)	EC2 <sup>3</sup> (2")	L2 (20W)	D101 (0-10V Dimming 1%)	27 (277V Non-IC only, for	1400 (Wood Joist Bar Hangers)
			L3 <sup>4</sup> (26W)	ED10V1 <sup>6</sup> (eldoLED 0-10V 1%)	-IC/-CP housing options	-EM7 <sup>9</sup> (7W Emergency Backup
				ED10V01 <sup>6</sup> (eldoLED 0-10V 0.1%)	use blank)	IOTA Part #ILB-CP07-A)
				LUT <sup>7</sup> (Lutron® LDE1 EcoSystem 1%)		-EM12 <sup>2,10</sup> (12W Emergency Backup
				LUT2 <sup>5</sup> (Lutron® LTEA2W 2-Wire 1%)		IOTA Part #ILB-CP12-A)
				DMXR <sup>8</sup> (DMX512 RDM 0.1%)		

## Trim Part Number (Example: MXTG2-RTRA300W-SFL13024)

Trim	Finish	Wattage	CCT / CRI	Optic
MXTG2-RTRA300 (1" Regress)	B-SF (Black / Self Flanged)	L0 (10W)	27 (2700K / 82 CRI)	09 <sup>12</sup> (9° Narrow Spot)
	B-SFW (Black / Self Flanged White)	L1 (16W)	279 (2700K / 92 CRI)	12 (12° Spot)
MXTG2-RTRR300 (1/2" Regress)	W-SF (White / Self Flanged)	L2 (20W)	30 (3000K / 82 CRI)	24 (24° Narrow Flood)
	SN-SF (Satin Nickel / Self Flanged)	L3 <sup>4</sup> (26W)	309 (3000K / 92 CRI)	36 (36° Flood)
	SN-SFW <sup>11</sup> (Satin Nickel / Self Flanged White)		35 (3500K / 82 CRI)	50 (50° Wide Flood)
	AB-SF (Antique Bronze / Self Flanged)		359 (3500K / 92 CRI)	
	AB-SFW <sup>11</sup> (Antique Bronze / Self Flanged White)		41 (4100K / 82 CRI)	
	WH-SF (Wheat / Self Flanged)		419 (4100K / 92 CRI)	
	WH-SFW <sup>11</sup> (Wheat / Self Flanged White)			

- Notes:
- ENERGY STAR® Qualified (White reflectors only; Excludes: L2, L3, 92 CRI & 9° options)
  - Excludes: L2, L3, 82 CRI & 9° options
  - EC1/EC2 not available with (-CP) Chicago Plenum
  - L3 available with Non-IC housings only
  - Available in L2 & L3
  - Not Available in L3
  - Not Available in L2 & L3
  - DMX512 RDM not available in L0 & L1
  - Access above ceiling required; not available with (-CP) Chicago Plenum
  - Not available in L0
  - Consult factory for lead times
  - 9° NS available in 279 with L0 or L1 Only

MX ADJUSTABLE L/M-11221 P-1

INTENSE LIGHTING | 3340 E La Palma Ave, Anaheim, CA 92806 | tel 714 630-9877 | fax 714 630-9883

For Intense Lighting's limited product warranty, go to [www.intenselighting.com](http://www.intenselighting.com). For a printed copy of the warranty, you may call 800 961-5321.

© 2021 Intense Lighting, LLC. All rights reserved. Note: This document is subject to change without notice.

intense<sup>®</sup> | a LEVITON<sup>®</sup> company

# MXG2ARTR

3.5" MX G2 LED Adjustable

JOB NAME		CATALOG NUMBER	
NOTES		TYPE	

## NON-IC & AIR TIGHT IC DIMENSIONS

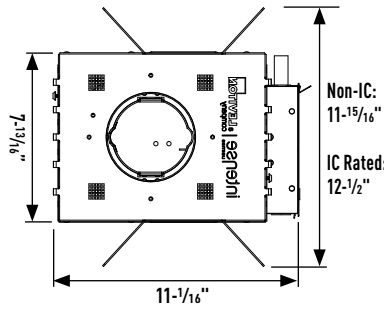
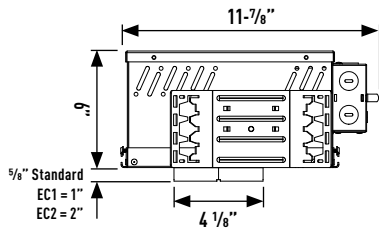

Ceiling Cut Out: 4 1/8"

### Plaster Frame Accommodation

Collar Type	Standard	EC1	EC2
Max Ceiling Thickness	Up-to 5/8"	Up-to 1"	Up-to 2"

## CCEA CHICAGO PLENUM DIMENSIONS

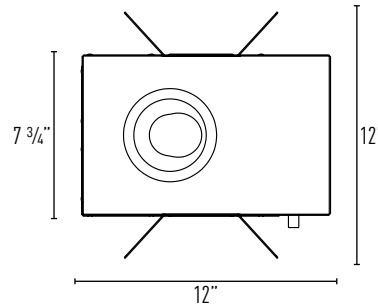
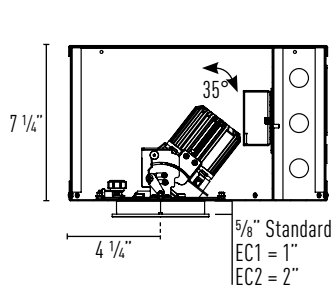

Ceiling Cut Out: 4 1/8"

### Plaster Frame Accommodation

Collar Type	Standard	EC1	EC2
Max Ceiling Thickness	Up-to 5/8"	Up-to 1"	Up-to 2"

## ACCESSORIES

Luminaire will accommodate (2) accessories, accessory holder required.

### INSTALLATION

1. Rotate release cap by turning counter clockwise.
2. Install accessories into accessory holder and replace accessory holder's retaining clip.
3. Place accessory holder and accessory flush against optic and replace release cap.

### Accessories

LH47	(Accessory Holder, Black)
LH47W	(Accessory Holder, White)
PFLMB-47	(Hex Louver, Black)
PFL1-47	(Prismatic Spread Lens)
PFL2-47	(Linear Spread Lens)
PFL4-47	(Soft Focus Lens)

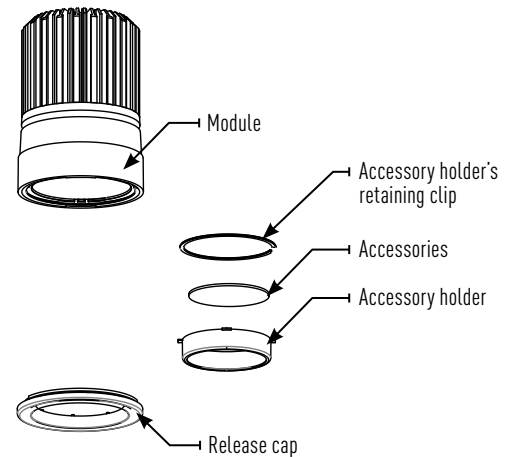

## OPTICS REPLACEMENT

1. Rotate release cap by turning counter clockwise.
2. Install accessories into accessory holder and replace accessory holder's retaining clip.
3. Place accessory holder and accessory flush against optic and replace release cap.

### Optics

IP-OP4712	(12° Spot)
IP-OP4724	(24° Narrow Flood)
IP-OP4736	(36° Flood)
IP-OP4750	(50° Wide Flood)

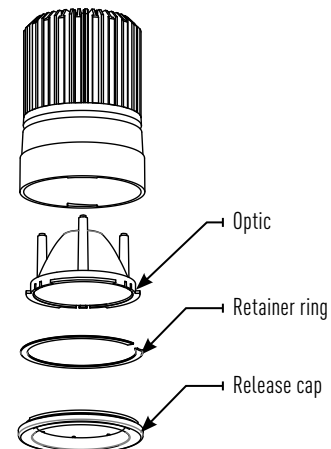

MX ADJUSTABLE L/M-1112.21 P-2

INTENSE LIGHTING | 3340 E La Palma Ave, Anaheim, CA 92806 | tel 714 630-9877 | fax 714 630-9883

For Intense Lighting's limited product warranty, go to [www.intenselighting.com](http://www.intenselighting.com). For a printed copy of the warranty, you may call 800 961-5321.

© 2021 Intense Lighting, LLC. All rights reserved. Note: This document is subject to change without notice.

JOB NAME		CATALOG NUMBER	
NOTES		TYPE	

## MXTG2-RTRA300WLO

Report #: ILL-01262016-39 (12)  
 ILL-01262016-42 (24)  
 ILL-01262016-45 (36)  
 ILL-01262016-48 (50)

### MXTG2-RTRA300

Ceiling Thickness Multipliers:  
 5/8" Thickness (x 1.00)  
 1" Thickness (x 0.87)  
 2" Thickness (x 0.74)

### MXTG2-RTRR300

Ceiling Thickness Multipliers:  
 5/8" Thickness (x 0.80)  
 1" Thickness (x 0.69)  
 2" Thickness (x 0.58)

### CCT MULTIPLIERS:

	<b>82 CRI</b>	<b>92 CRI</b>
2700K	(x 0.93)	(x 0.76)
3000K	(x 1.00)	(x 0.87)
3500K	(x 1.00)	(x 0.87)
4100K	(x 1.00)	(x 0.87)

### EMERGENCY MULTIPLIER:

7W Emergency (x 0.70)

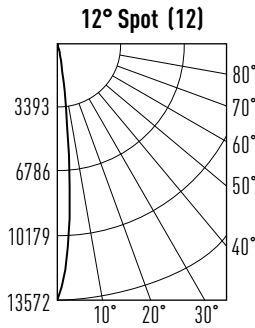

Watts: 10  
 Lumens: 783  
 LPW: 78  
 CCT: 3000K

#### Candelas at Nadir

Degree	Candela
0°	13572
5°	7578
15°	566
25°	95
35°	34
45°	5

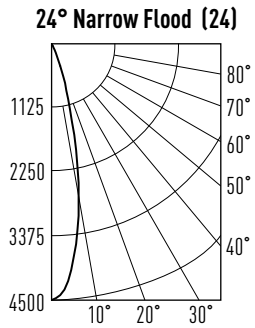

Watts: 10  
 Lumens: 875  
 LPW: 87  
 CCT: 3000K

#### Candelas at Nadir

Degree	Candela
0°	4500
5°	3982
15°	1402
25°	227
35°	25
45°	3

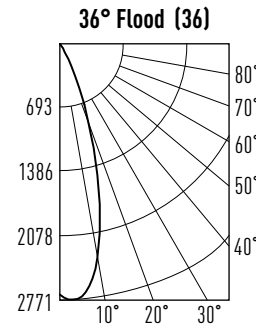

Watts: 10  
 Lumens: 964  
 LPW: 96  
 CCT: 3000K

#### Candelas at Nadir

Degree	Candela
0°	2771
5°	2742
15°	1629
25°	457
35°	72
45°	6

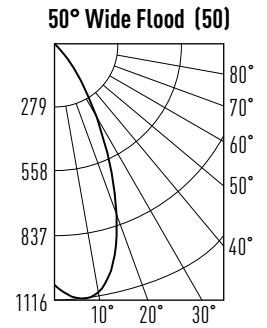

Watts: 10  
 Lumens: 836  
 LPW: 84  
 CCT: 3000K

#### Candelas at Nadir

Degree	Candela
0°	1049
5°	1111
15°	988
25°	571
35°	222
45°	57

### APPLICATION DATA:

**W** and **L** are the outer points where the candle power drops to 50% of maximum. **FC** are the initial footcandles at the center of the beam.

- W** Beam width
- L** Beam length
- C** Distance to center of beam
- D** Distance
- FC** Footcandles

Illuminated width & length are based upon point at which illuminance falls to 50% of center illuminance. Recommended spacing is based upon uniform illuminance aiming angle is the angle between the lamp axis and the perpendicular to the illuminated plane.

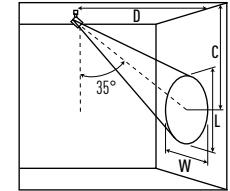
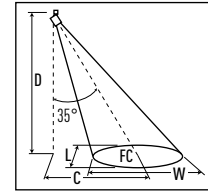
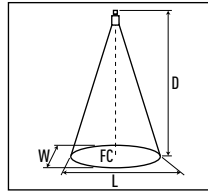

	0° HORIZONTAL				35° HORIZONTAL				35° VERTICAL					
	D	FC	W	L	D	C	FC	W	L	D	C	FC	W	L
<b>MXTG2-RTRA300WLO 3000K 12° Spot</b>	6'	377	1.2	1.2	6'	4	202	1.7	1.35	3'	4	387	1.12	1.86
	8'	212	1.6	1.6	8'	5	103	2.5	1.81	4'	6	202	1.35	2.55
	10'	136	1.9	1.9	10'	7	74.6	2.9	2.43	5'	7	145	1.58	2.94
	12'	94.2	2.3	2.3	12'	8	50.5	3.47	2.92	6'	8	96.8	1.98	3.61
<b>MXTG2-RTRA300WLO 3000K 24° Narrow Flood</b>	6'	125	2.5	2.5	6'	4	71.2	3.39	2.97	3'	4	141	2	3.27
	8'	70.3	3.4	3.4	8'	5	41.1	4.39	3.76	4'	5	80.4	2.69	4.26
	10'	45	4.2	4.2	10'	6	26.3	5.52	4.72	5'	6	50.6	3.4	5.35
	12'	31.2	5	5	12'	7	18	6.69	5.75	6'	8	35.4	4.02	6.36
<b>MXTG2-RTRA300WLO 3000K 36° Flood</b>	6'	75.3	3.6	3.6	6'	3	50	4.19	3.68	3'	3	92.2	2.81	4.03
	8'	42.4	4.7	4.7	8'	4	28.2	5.54	4.97	4'	5	52.7	3.52	5.33
	10'	27.1	5.9	5.9	10'	5	18	6.93	6.18	5'	6	34.6	4.48	6.5
	12'	18.8	7.1	7.1	12'	6	12.5	8.32	7.39	6'	7	24.3	5.23	7.71
<b>MXTG2-RTRA300WLO 3000K 50° Wide Flood</b>	6'	29.1	5.6	5.6	6'	2	22.2	5.32	5.16	3'	3	43.1	3.53	4.49
	8'	16.4	7.4	7.4	8'	3	12.9	6.84	6.72	4'	4	24.3	4.75	5.9
	10'	10.5	9.3	9.3	10'	4	8.3	8.49	8.38	5'	5	15.5	5.95	7.44
	12'	5.8	11.1	11.1	12'	5	5.8	10.14	10.01	6'	6	10.8	7.12	8.87

JOB NAME		CATALOG NUMBER	
NOTES		TYPE	

## MXTG2-RTRA300WL1

Report #: ILL-01262016-15 (12)  
 ILL-01262016-18 (24)  
 ILL-01262016-21 (36)  
 ILL-01262016-24 (50)

**MXTG2-RTRA300**  
 Ceiling Thickness Multipliers:  
 5/8" Thickness (x 1.00)  
 1" Thickness (x 0.87)  
 2" Thickness (x 0.74)

**MXTG2-RTRR300**  
 Ceiling Thickness Multipliers:  
 5/8" Thickness (x 0.80)  
 1" Thickness (x 0.69)  
 2" Thickness (x 0.58)

### CCT MULTIPLIERS:

	<b>82 CRI</b>	<b>92 CRI</b>
2700K	(x 0.93)	(x 0.76)
3000K	(x 1.00)	(x 0.87)
3500K	(x 1.00)	(x 0.87)
4100K	(x 1.00)	(x 0.87)

### EMERGENCY MULTIPLIER:

7W Emergency	(x 0.50)
12W Emergency	(x 0.85)

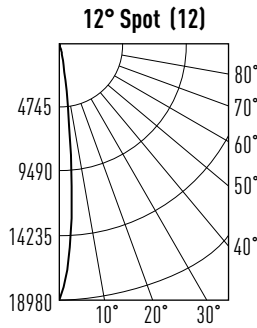

Watts: 15.6  
 Lumens: 1088  
 LPW: 70  
 CCT: 3000K

### Candelas at Nadir

Degree	Candela
0°	18980
5°	10528
15°	788
25°	131
35°	47
45°	7

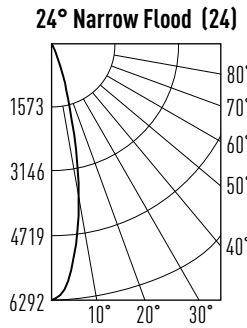

Watts: 15.6  
 Lumens: 1190  
 LPW: 76  
 CCT: 3000K

### Candelas at Nadir

Degree	Candela
0°	6292
5°	5536
15°	1898
25°	304
35°	32
45°	4

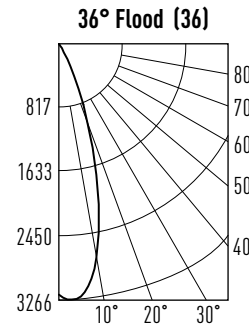

Watts: 15.6  
 Lumens: 1303  
 LPW: 84  
 CCT: 3000K

### Candelas at Nadir

Degree	Candela
0°	3236
5°	3217
15°	2121
25°	687
35°	136
45°	14

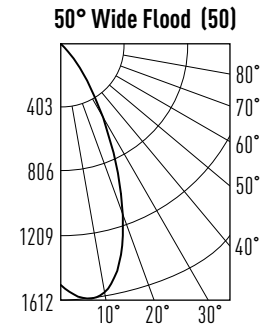

Watts: 15.6  
 Lumens: 1163  
 LPW: 75  
 CCT: 3000K

### Candelas at Nadir

Degree	Candela
0°	1523
5°	1607
15°	1397
25°	782
35°	301
45°	77

### APPLICATION DATA:

**W** and **L** are the outer points where the candle power drops to 50% of maximum. **FC** are the initial foot candles at the center of the beam.

- W** Beam width
- L** Beam length
- C** Distance to center of beam
- D** Distance
- FC** Footcandles

Illuminated width & length are based upon point at which illuminance falls to 50% of center illuminance. Recommended spacing is based upon uniform illuminance aiming angle is the angle between the lamp axis and the perpendicular to the illuminated plane.

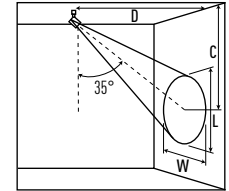
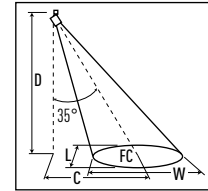
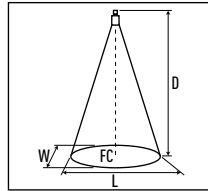

	0° HORIZONTAL				35° HORIZONTAL				35° VERTICAL					
	D	FC	W	L	D	C	FC	W	L	D	C	FC	W	L
<b>MXTG2-RTRA300WL1</b> <b>3000K</b> <b>12° Spot</b>	6'	527	1.2	1.2	6'	4	282	1.69	1.35	3'	4	540	1.12	1.85
	8'	297	1.5	1.5	8'	5	143	2.5	1.81	4'	6	282	1.34	2.54
	10'	190	1.9	1.9	10'	7	104	2.89	2.42	5'	7	203	1.57	2.92
	12'	132	2.3	2.3	12'	8	70.4	3.48	2.91	6'	8	135	1.98	3.6
<b>MXTG2-RTRA300WL1</b> <b>3000K</b> <b>24° Narrow Flood</b>	6'	175	2.5	2.5	6'	4	99.5	3.33	2.92	3'	4	197	1.95	3.22
	8'	98.3	3.3	3.3	8'	5	57.3	4.34	3.69	4'	5	112	2.64	4.19
	10'	62.9	4.1	4.1	10'	6	36.6	5.45	4.62	5'	6	70.4	3.35	5.28
	12'	43.7	4.9	4.9	12'	7	25.1	6.59	5.63	6'	8	49.3	3.92	6.28
<b>MXTG2-RTRA300WL1</b> <b>3000K</b> <b>36° Flood</b>	6'	89.9	3.8	3.8	6'	3	60.5	4.37	3.86	3'	3	114	2.9	4.05
	8'	50.6	5.1	5.1	8'	4	34	5.76	5.24	4'	4	64.2	3.66	5.45
	10'	32.4	6.4	6.4	10'	5	21.8	7.22	6.55	5'	5	41.1	4.76	6.78
	12'	22.5	7.7	7.7	12'	6	15.1	8.66	7.78	6'	7	28.5	5.6	8.14
<b>MXTG2-RTRA300WL1</b> <b>3000K</b> <b>50° Wide Flood</b>	6'	42.3	5.4	5.4	6'	3	31.8	5.27	5.06	3'	3	61.9	3.46	4.47
	8'	23.8	7.2	7.2	8'	3	18.3	6.83	6.6	4'	4	34.8	4.66	5.89
	10'	15.2	9	9	10'	4	11.8	8.48	8.23	5'	5	22.3	5.78	7.38
	12'	10.6	10.8	10.8	12'	5	8.2	10.17	9.89	6'	6	15.5	6.97	8.82

JOB NAME		CATALOG NUMBER	
NOTES		TYPE	

## MXTG2-RTRA300WL2

Report #: ILL-01262016-27 (12)  
 ILL-01262016-30 (24)  
 ILL-01262016-33 (36)  
 ILL-02102016-06 (50)

### MXTG2-RTRA300

Ceiling Thickness Multipliers:  
 5/8" Thickness (x 1.00)  
 1" Thickness (x 0.87)  
 2" Thickness (x 0.74)

### MXTG2-RTRR300

Ceiling Thickness Multipliers:  
 5/8" Thickness (x 0.80)  
 1" Thickness (x 0.69)  
 2" Thickness (x 0.58)

### CCT MULTIPLIERS:

	<b>82 CRI</b>	<b>92 CRI</b>
2700K	(x 0.93)	(x 0.76)
3000K	(x 1.00)	(x 0.87)
3500K	(x 1.00)	(x 0.87)
4100K	(x 1.00)	(x 0.87)

### EMERGENCY MULTIPLIER:

7W Emergency (x 0.40)  
 12W Emergency (x 0.68)

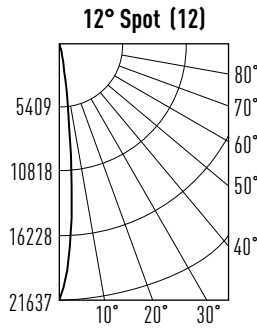

Watts: 20.4  
 Lumens: 1346  
 LPW: 66  
 CCT: 3000K

#### Candelas at Nadir

Degree	Candela
0°	21637
5°	13518
15°	817
25°	175
35°	69
45°	10

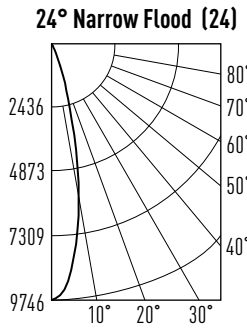

Watts: 20.4  
 Lumens: 1549  
 LPW: 76  
 CCT: 3000K

#### Candelas at Nadir

Degree	Candela
0°	9746
5°	8206
15°	2395
25°	275
35°	34
45°	4

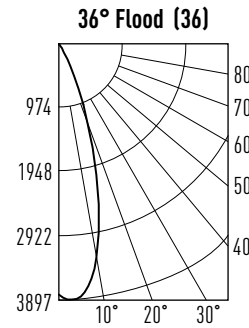

Watts: 20.4  
 Lumens: 1576  
 LPW: 77  
 CCT: 3000K

#### Candelas at Nadir

Degree	Candela
0°	3884
5°	3842
15°	2579
25°	832
35°	170
45°	14

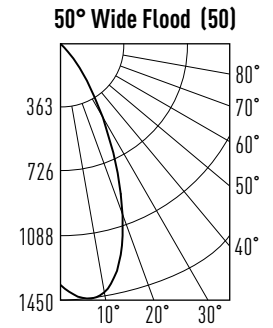

Watts: 20.8  
 Lumens: 1230  
 LPW: 59  
 CCT: 3000K

#### Candelas at Nadir

Degree	Candela
0°	1432
5°	1447
15°	1338
25°	837
35°	355
45°	110

### APPLICATION DATA:

**W** and **L** are the outer points where the candle power drops to 50% of maximum. **FC** are the initial footcandles at the center of the beam.

**W** Beam width  
**L** Beam length  
**C** Distance to center of beam  
**D** Distance  
**FC** Footcandles

Illuminated width & length are based upon point at which illuminance falls to 50% of center illuminance. Recommended spacing is based upon uniform illuminance aiming angle is the angle between the lamp axis and the perpendicular to the illuminated plane.

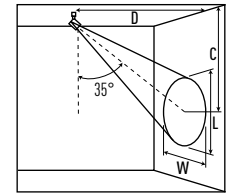
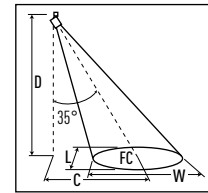
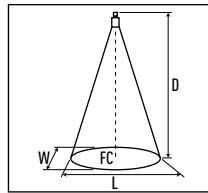

	0° HORIZONTAL				35° HORIZONTAL				35° VERTICAL					
	D	FC	W	L	D	C	FC	W	L	D	C	FC	W	L
<b>MXTG2-RTRA300WL2</b> 3000K 12° Spot	6'	601	1.3	1.3	6'	4	341	1.78	1.37	3'	4	672	1.11	1.89
	8'	338	1.7	1.7	8'	5	185	2.48	1.77	4'	6	341	1.38	2.63
	10'	216	2.1	2.1	10'	7	119	3.16	2.68	5'	7	237	1.67	3.14
	12'	150	2.5	2.5	12'	8	85.1	3.64	3.05	6'	8	168	2.04	3.7
<b>MXTG2-RTRA300WL2</b> 3000K 24° Narrow Flood	6'	271	2.3	2.3	6'	4	153	3.12	2.71	3'	4	302	1.79	3.04
	8'	152	3	3	8'	5	86.8	4.07	3.46	4'	5	168	2.5	4.03
	10'	97.5	3.8	3.8	10'	6	54.9	5.14	4.38	5'	7	107	3.16	5
	12'	67.7	4.5	4.5	12'	8	38.3	6.14	5.3	6'	8	75.6	3.66	5.89
<b>MXTG2-RTRA300WL2</b> 3000K 36° Flood	6'	108	3.9	3.9	6'	3	72.7	4.38	3.89	3'	3	137	2.91	4.05
	8'	60.7	5.2	5.2	8'	4	40.9	5.78	5.28	4'	4	77.3	3.7	5.46
	10'	38.8	6.5	6.5	10'	5	26.2	7.25	6.59	5'	5	49.4	4.79	6.8
	12'	27	7.8	7.8	12'	6	18.2	8.66	7.84	6'	6	34.3	5.63	8.13
<b>MXTG2-RTRA300WL2</b> 3000K 50° Wide Flood	6'	39.8	6	6	6'	2	30.4	5.27	5.31	3'	3	56.5	3.74	4.56
	8'	22.4	8	8	8'	3	17.4	6.9	7.01	4'	4	31.8	5.01	6.01
	10'	14.3	10	10	10'	4	11.1	8.61	8.76	5'	5	20.3	6.31	7.57
	12'	10	12	12	12'	5	7.7	10.33	10.52	6'	6	14.1	7.56	9.04

<b>JOB NAME</b>		<b>CATALOG NUMBER</b>	
<b>NOTES</b>		<b>TYPE</b>	

## MXTG2-RTRA300WL3

Report #: ILL-01262016-12 (12)  
 ILL-01262016-09 (24)  
 ILL-01262016-03 (36)  
 ILL-02102016-05 (50)

### MXTG2-RTRA300

Ceiling Thickness Multipliers:  
 5/8" Thickness (x 1.00)  
 1" Thickness (x 0.87)  
 2" Thickness (x 0.74)

### MXTG2-RTRR300

Ceiling Thickness Multipliers:  
 5/8" Thickness (x 0.80)  
 1" Thickness (x 0.69)  
 2" Thickness (x 0.58)

### CCT MULTIPLIERS:

	82 CRI	92 CRI
2700K	(x 0.93)	(x 0.76)
3000K	(x 1.00)	(x 0.87)
3500K	(x 1.00)	(x 0.87)
4100K	(x 1.00)	(x 0.87)

### EMERGENCY MULTIPLIER:

7W Emergency (x 0.35)  
 12W Emergency (x 0.59)

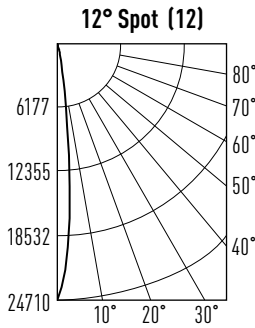

Watts: 26.3  
 Lumens: 1571  
 LPW: 60  
 CCT: 3000K

### Candelas at Nadir

Degree	Candela
0°	24710
5°	15868
15°	885
25°	193
35°	74
45°	12

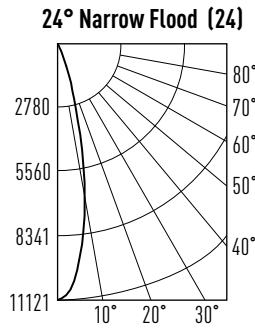

Watts: 26.3  
 Lumens: 1889  
 LPW: 72  
 CCT: 3000K

### Candelas at Nadir

Degree	Candela
0°	11121
5°	9654
15°	2982
25°	345
35°	40
45°	5

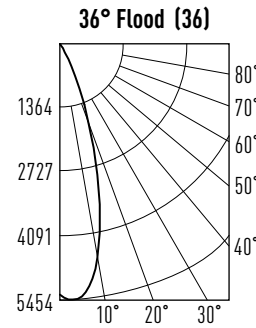

Watts: 26.3  
 Lumens: 1854  
 LPW: 70  
 CCT: 3000K

### Candelas at Nadir

Degree	Candela
0°	5418
5°	5336
15°	3094
25°	845
35°	150
45°	13

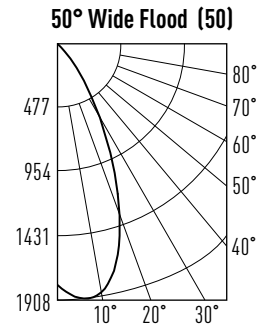

Watts: 26.6  
 Lumens: 1616  
 LPW: 61  
 CCT: 3000K

### Candelas at Nadir

Degree	Candela
0°	1887
5°	1905
15°	1758
25°	1099
35°	467
45°	144

### APPLICATION DATA:

**W** and **L** are the outer points where the candle power drops to 50% of maximum. **FC** are the initial foot candles at the center of the beam.

- W** Beam width
- L** Beam length
- C** Distance to center of beam
- D** Distance
- FC** Footcandles

Illuminated width & length are based upon point at which illuminance falls to 50% of center illuminance. Recommended spacing is based upon uniform illuminance aiming angle is the angle between the lamp axis and the perpendicular to the illuminated plane.

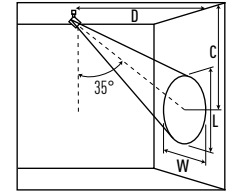
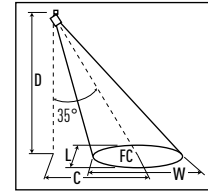
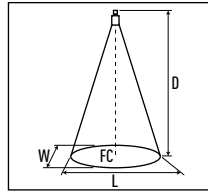

	0° HORIZONTAL				35° HORIZONTAL				35° VERTICAL					
	D	FC	W	L	D	C	FC	W	L	D	C	FC	W	L
<b>MXTG2-RTRA300WL3</b> 3000K 12° Spot	6'	686	1.3	1.3	6'	4	387	1.83	1.41	3'	4	753	1.11	1.92
	8'	386	1.7	1.7	8'	5	212	2.5	1.84	4'	6	387	1.41	2.7
	10'	247	2.2	2.2	10'	7	136	3.19	2.72	5'	7	271	1.72	3.2
	12'	172	2.6	2.6	12'	8	96.7	3.74	3.11	6'	8	188	2.19	3.81
<b>MXTG2-RTRA300WL3</b> 3000K 24° Narrow Flood	6'	309	2.4	2.4	6'	4	176	3.22	2.8	3'	4	347	1.88	3.13
	8'	174	3.2	3.2	8'	5	101	4.18	3.57	4'	5	196	2.56	4.1
	10'	111	4	4	10'	6	63.7	5.3	4.53	5'	6	123	3.28	5.15
	12'	77.2	4.7	4.7	12'	8	43.9	6.39	5.5	6'	8	86.8	3.8	6.08
<b>MXTG2-RTRA300WL3</b> 3000K 36° Flood	6'	150	3.5	3.5	6'	3	96.6	4.17	3.64	3'	3	177	2.8	4.02
	8'	84.6	4.7	4.7	8'	4	54.3	5.52	4.93	4'	5	103	3.46	5.24
	10'	54.2	5.8	5.8	10'	5	34.8	6.89	6.09	5'	6	67.3	4.37	6.43
	12'	37.6	7	7	12'	6	24.1	8.27	7.34	6'	7	47.1	5.16	7.65
<b>MXTG2-RTRA300WL3</b> 3000K 50° Wide Flood	6'	52.4	6	6	6'	2	39.9	5.28	5.33	3'	3	74.3	3.74	4.55
	8'	29.5	8	8	8'	3	22.8	6.92	7.01	4'	4	41.8	5.01	6
	10'	18.9	10	10	10'	4	14.6	8.62	8.74	5'	5	26.7	6.3	7.57
	12'	13.1	12	12	12'	5	10.1	10.36	10.54	6'	6	18.6	7.53	9.01