

MXG2ARTR

3.5" MX G2 LED Lensed Adjustable Non-Conductive - Wet Location

JOB NAME		CATALOG NUMBER	
NOTES		TYPE	

ELECTRICAL DATA

LED Light Engine	System Wattage *	CCT / CRI	Delivered Lumens **	Lumens Per Watt
L0	10W	3000K / 82 CRI	700lm	70
L1	16W	3000K / 82 CRI	950lm	59
L2	20W	3000K / 82 CRI	1150lm	57
L3	26W	3000K / 82 CRI	1350lm	52

*System Wattage include driver and LED Module consumption. **Delivered lumens will vary depending on trim, CCT, CRI, optic and ceiling thickness

FEATURES

- Non-metallic trim with integral lens
- High center beam spot up to 20,000 CBCP
- Dedicated 9° with field changeable 12°, 24°, 36° & 50° optics

LED LIGHT ENGINE

- 92 CRI & 82 CRI in 2700K, 3000K, 3500K or 4100K with 2SDCM binning
- >50,000 hours L70 (rated life at 70% output)

ELECTRICAL SYSTEM

- (Non-IC) Dedicated voltage options of 120V or 277V. Must be specified in catalog code.
- (-IC/-CP) Universal 120V/277V input
- This product complies with IEEE C62.41 for surge endurance up to 2.5KV. Additional surge protection recommended. Damage from power surge is not covered by warranty.

DIMMING

- 0-10V Dimming 1%
- Forward/reverse dimming 1% (120V only)
- EldoLED 0-10V 0.1% or 1%
- Lutron® LDE1 Hi-Lume 1% EcoSystem LED driver with Soft-on, Fade-to-Black dimming technology
- Lutron® LTEA2W Hi-Lume 1% 2-Wire LED driver (120V forward phase only)
- DMX512 RDM 0.1%

HOUSING

- Heavy duty black powder coated 18 gauge steel frame
- Standard housing accommodates 5/8" ceiling thickness
- Extended collar options available for ceilings up to 1" or 2" thick, must specify either EC1 or EC2 (EC1/EC2 Not available with Chicago Plenum)

ADJUSTABLE HOUSING

Aiming with locking 35° vertical and 360° horizontal adjustment.

TRIM SPECIFICATION

Non-reactive trim made of heavy duty injection molded polymer with solite, clear tempered or frosted lens, must specify.

INSTALLATION

Housing types include IC Air-Tight, CCEA (Chicago Plenum), or Non-IC Rated (must specify). Non-IC rated housings must be kept at a minimum of 3" away from insulation. Butterfly brackets are compatible with C-channel, adjustable bar hangers (14"-25") and EMT. C-channel is recommended for T-bar ceilings. Bar hangers must be ordered separately. Max. ambient temperature: 95°F (35°C).

EMERGENCY BACKUP

Remote test switch included. External battery operates LED load at a minimum of 400 to 650 lumens for 90 minutes, depending on backup wattage selected. See trim multipliers for detailed performance. Servicing requires above ceiling access. (EM not available with Chicago Plenum)

LISTING / WARRANTY

- 5-Year Intense LED Limited Warranty
- ETL listed to US and Canadian standards for wet locations
- ENERGY STAR® Qualified¹
- Can be used to comply with 2016 Title 24, Part 6, JA8 high efficacy LED light source requirements²



MXTG2-RNRR302
(1/2" Regress)

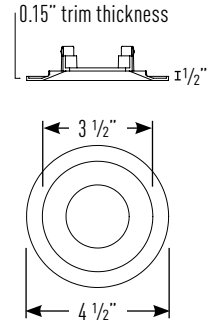

Housing dimensions are on Page 2

Housing Part Number (Example: MXG2DRTR-NCL1)

Housing	Installation Type	Ceiling Thickness	Wattage	Dimming	Voltage	Options
MXG2ARTR	-NC (Non-IC)	blank (5/8")	L0 (10W)	blank (Non-Dimming)	blank (Non-IC: 120V	I100 (C-Channel Bar Hangers)
	-IC (Air-Tight IC)	EC1 ³ (1")	L1 (16W)	DELV ⁵ (Phase Dimming)	-IC/-CP: 120V/277V)	I200 (Flat Bar Hangers)
	-CP (Chicago Plenum)	EC2 ³ (2")	L2 (20W)	D101 (0-10V Dimming 1%)	27 (277V Non-IC Only, for -IC/-CP housing options use blank)	I400 (Wood Joist Bar Hangers)
			L3 ⁴ (26W)	ED10V1 ⁶ (eldoLED 0-10V 1%)		EM7 ⁹ (7W Emergency Backup IOTA Part #ILB-CP07-A)
			ED10V01 ⁶ (eldoLED 0-10V 0.1%)			EM12 ¹⁰ (12W Emergency Backup IOTA Part #ILB-CP12-A)
			LUT ⁷ (Lutron® LDE1 EcoSystem 1%)			
			LUT2 ⁵ (Lutron® LTEA2W 2-Wire 1%)			
			DMXR ⁸ (DMX512 RDM 0.1%)			

Trim Part Number (Example: MXTG2-RNRR302WL13024-SL)

Trim	Finish	Wattage	CCT / CRI	Optic	Lens
MXTG2-RNRR302 (1/2" Regress with Lens)	W (White Non-Conductive)	L0 (10W)	27 (2700K / 82 CRI)	09 ¹¹ (9° Narrow Spot)	-SL (Solite)
		L1 (16W)	279 (2700K / 92 CRI)	12 (12° Spot)	-CR (Clear Tempered)
		L2 (20W)	30 (3000K / 82 CRI)	24 (24° Narrow Flood)	-FR (Frosted)
		L3 ⁴ (26W)	309 (3000K / 92 CRI)	36 (36° Flood)	
			35 (3500K / 82 CRI)	50 (50° Wide Flood)	
			359 (3500K / 92 CRI)		
			41 (4100K / 82 CRI)		
			419 (4100K / 92 CRI)		

Notes:

- ENERGY STAR® Qualified (White reflectors only; Excludes: L2, L3, 92 CRI & 9° options)
- L0 only; Excludes: 82 CRI & 9° options
- EC1/EC2 not available with (-CP) Chicago Plenum
- L3 available with Non-IC housings only
- Not Available in 277V
- Not Available in L3
- Not Available in L2 & L3
- DMX512 RDM not available in L0 & L1
- Access above ceiling required; not available with (-CP) Chicago Plenum
- Not available in L0
- 9° NS available in 279 with L0 or L1 Only

MX ADJUSTABLE NON CONDUCTIVE L/M-0826-21 P-5

INTENSE LIGHTING | 3340 E La Palma Ave, Anaheim, CA 92806 | tel 714 630-9877 | fax 714 630-9883

For Intense Lighting's limited product warranty, go to www.intenselighting.com. For a printed copy of the warranty, you may call 800 961-5321.

© 2021 Intense Lighting, LLC. All rights reserved. Note: This document is subject to change without notice.

MXG2ARTR

3.5" MX G2 LED Lensed Adjustable Non-Conductive - Wet Location

JOB NAME		CATALOG NUMBER	
NOTES		TYPE	

NON-IC & AIR TIGHT IC DIMENSIONS

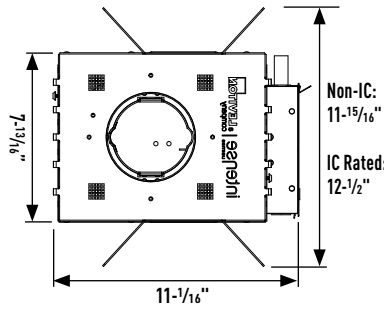
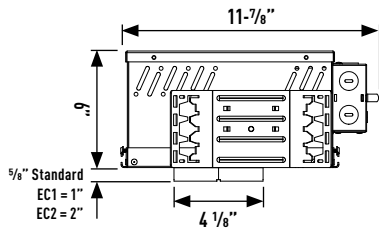

Ceiling Cut Out: 4 1/8"

Plaster Frame Accommodation

Collar Type	Max Ceiling Thickness
Standard	Up-to 5/8"
EC1	Up-to 1"
EC2	Up-to 2"

CCEA CHICAGO PLENUM DIMENSIONS

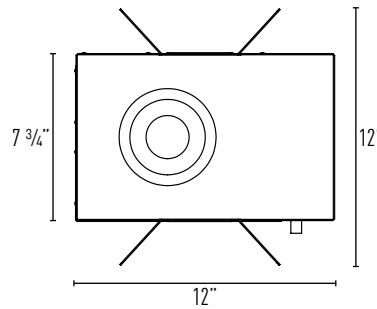
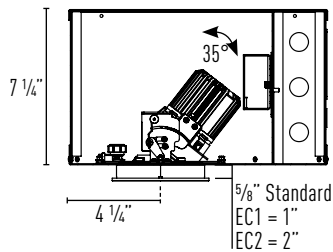

Ceiling Cut Out: 4 1/8"

Plaster Frame Accommodation

Collar Type	Max Ceiling Thickness
Standard	Up-to 5/8"
EC1	Up-to 1"
EC2	Up-to 2"

OPTICS REPLACEMENT

1. Rotate release cap by turning counter clockwise.
2. Install accessories into accessory holder and replace accessory holder's retaining clip.
3. Place accessory holder and accessory flush against optic and replace release cap.

Optics

- IP-OP4712 (12° Spot)
- IP-OP4724 (24° Narrow Flood)
- IP-OP4736 (36° Flood)
- IP-OP4750 (50° Wide Flood)

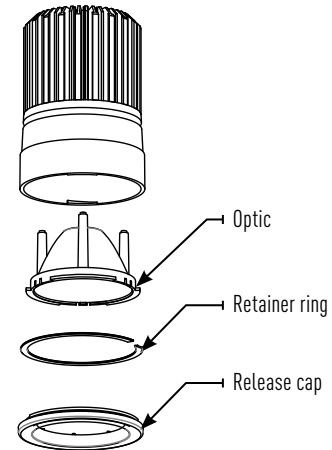

JOB NAME		CATALOG NUMBER	
NOTES		TYPE	

MXTG2-RNRR302LO-CR

Report #: ILL-01262016-39 (12)
 ILL-01262016-42 (24)
 ILL-01262016-45 (36)
 ILL-01262016-48 (50)

MXTG2-RNRR302
 Ceiling Thickness Multipliers:
 5/8" Thickness (x 1.00)
 1" Thickness (x 0.87)
 2" Thickness (x 0.73)

CCT MULTIPLIERS:

	82 CRI	92 CRI
2700K	(x 0.93)	(x 0.76)
3000K	(x 1.00)	(x 0.87)
3500K	(x 1.00)	(x 0.87)
4100K	(x 1.00)	(x 0.87)

LENS MULTIPLIERS:

Solite	(x 0.92)
Clear	(x 1.00)
Frosted	(x 0.92)

EMERGENCY MULTIPLIER:

7W Emergency	(x 0.70)
--------------	----------

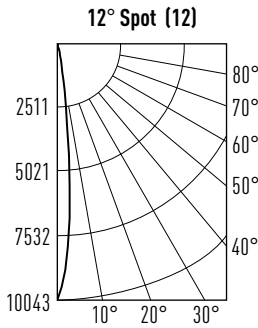

Watts: 10
 Lumens: 579
 LPW: 58
 CCT: 3000K

Candelas at Nadir	
Degree	Candela
0°	10043
5°	5608
15°	419
25°	70
35°	25
45°	4

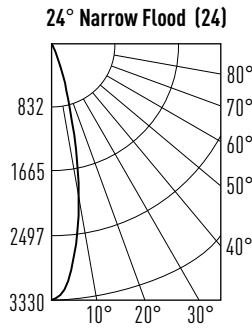

Watts: 10
 Lumens: 647
 LPW: 65
 CCT: 3000K

Candelas at Nadir	
Degree	Candela
0°	3330
5°	2947
15°	1038
25°	168
35°	18
45°	2

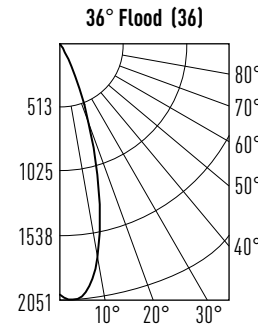

Watts: 10
 Lumens: 714
 LPW: 71
 CCT: 3000K

Candelas at Nadir	
Degree	Candela
0°	2006
5°	2029
15°	1205
25°	338
35°	54
45°	4

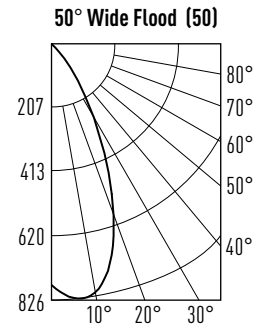

Watts: 10
 Lumens: 818
 LPW: 62
 CCT: 3000K

Candelas at Nadir	
Degree	Candela
0°	776
5°	822
15°	731
25°	423
35°	164
45°	42

APPLICATION DATA:

W and **L** are the outer points where the candle power drops to 50% of maximum. **FC** are the initial footcandles at the center of the beam.

W Beam width
L Beam length
C Distance to center of beam
D Distance
FC Footcandles

Illuminated width & length are based upon point at which illuminance falls to 50% of center illuminance. Recommended spacing is based upon uniform illuminance aiming angle is the angle between the lamp axis and the perpendicular to the illuminated plane.

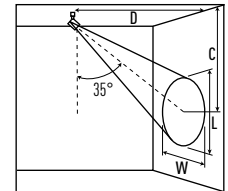
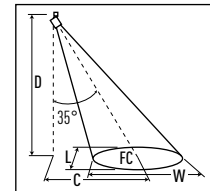
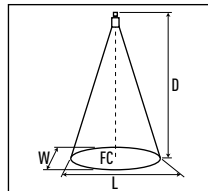

	0° HORIZONTAL				35° HORIZONTAL				35° VERTICAL					
	D	FC	W	L	D	C	FC	W	L	D	C	FC	W	L
MXTG2-RNRR302WLO-CR 3000K 12° Spot	6'	279	1.2	1.2	6'	4	149	1.7	1.35	3'	4	287	1.12	1.86
	8'	157	1.6	1.6	8'	5	76.1	2.5	1.81	4'	6	149	1.35	2.55
	10'	100	1.9	1.9	10'	7	55.2	2.9	2.43	5'	7	108	1.58	2.94
	12'	69.7	2.3	2.3	12'	8	37.3	3.47	2.92	6'	8	71.6	1.98	3.61
MXTG2-RNRR302WLO-CR 3000K 24° Narrow Flood	6'	92.5	2.5	2.5	6'	4	52.7	3.39	2.97	3'	4	105	2	3.27
	8'	52	3.4	3.4	8'	5	30.5	4.39	3.76	4'	5	59.5	2.69	4.26
	10'	33.3	4.2	4.2	10'	6	19.5	5.52	4.72	5'	6	37.5	3.4	5.35
	12'	23.1	5	5	12'	7	13.4	6.69	5.75	6'	8	26.2	4.02	6.36
MXTG2-RNRR302WLO-CR 3000K 36° Flood	6'	55.7	3.6	3.6	6'	3	37	4.19	3.68	3'	3	68.2	2.81	4.03
	8'	31.3	4.7	4.7	8'	4	20.8	5.54	4.97	4'	5	39	3.52	5.33
	10'	20.1	5.9	5.9	10'	5	13.3	6.93	6.18	5'	6	25.6	4.48	6.5
	12'	13.9	7.1	7.1	12'	6	9.3	8.32	7.39	6'	7	18	5.23	7.71
MXTG2-RNRR302WLO-CR 3000K 50° Wide Flood	6'	21.6	5.6	5.6	6'	2	16.4	5.32	5.16	3'	3	31.9	3.53	4.49
	8'	12.1	7.4	7.4	8'	3	9.5	6.84	6.72	4'	4	18	4.75	5.9
	10'	7.8	9.3	9.3	10'	4	6.2	8.49	8.38	5'	5	11.5	5.95	7.44
	12'	5.4	11.1	11.1	12'	5	4.3	10.14	10.01	6'	6	8	7.12	8.87

JOB NAME		CATALOG NUMBER	
NOTES		TYPE	

MXTG2-RNRR302L1-CR

Report #: ILL-01262016-15 (12)
 ILL-01262016-18 (24)
 ILL-01262016-21 (36)
 ILL-01262016-24 (50)

MXTG2-RNRR302

Ceiling Thickness Multipliers:
 5/8" Thickness (x 1.00)
 1" Thickness (x 0.87)
 2" Thickness (x 0.73)

CCT MULTIPLIERS:

	82 CRI	92 CRI
2700K	(x 0.93)	(x 0.76)
3000K	(x 1.00)	(x 0.87)
3500K	(x 1.00)	(x 0.87)
4100K	(x 1.00)	(x 0.87)

LENS MULTIPLIERS:

Solite	(x 0.92)
Clear	(x 1.00)
Frosted	(x 0.92)

EMERGENCY MULTIPLIER:

7W Emergency	(x 0.50)
12W Emergency	(x 0.85)

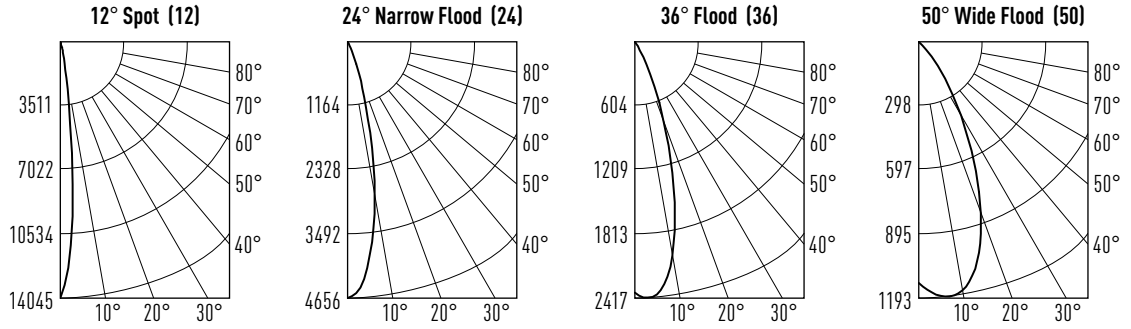

Watts: 15.6
 Lumens: 805
 LPW: 52
 CCT: 3000K

Watts: 15.6
 Lumens: 880
 LPW: 56
 CCT: 3000K

Watts: 15.6
 Lumens: 964
 LPW: 62
 CCT: 3000K

Watts: 15.6
 Lumens: 860
 LPW: 55
 CCT: 3000K

Candelas at Nadir

Degree	Candela
0°	14045
5°	7791
15°	583
25°	97
35°	35
45°	5

Candelas at Nadir

Degree	Candela
0°	4656
5°	4096
15°	1405
25°	225
35°	24
45°	3

Candelas at Nadir

Degree	Candela
0°	2395
5°	2381
15°	1570
25°	508
35°	101
45°	10

Candelas at Nadir

Degree	Candela
0°	1127
5°	1190
15°	1034
25°	579
35°	222
45°	57

APPLICATION DATA:

W and L are the outer points where the candle power drops to 50% of maximum. FC are the initial footcandles at the center of the beam.

W Beam width
 L Beam length
 C Distance to center of beam
 D Distance
 FC Footcandles

Illuminated width & length are based upon point at which illuminance falls to 50% of center illuminance. Recommended spacing is based upon uniform illuminance aiming angle is the angle between the lamp axis and the perpendicular to the illuminated plane.

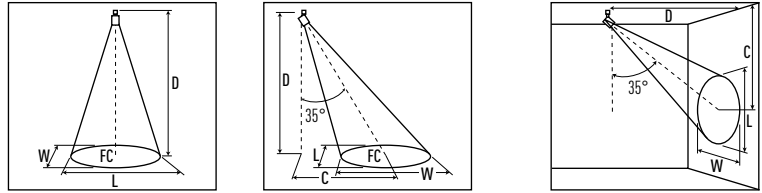

	0° HORIZONTAL				35° HORIZONTAL				35° VERTICAL					
	D	FC	W	L	D	C	FC	W	L	D	C	FC	W	L
MXTG2-RNRR302WL1-CR 3000K 12° Spot	6'	390	1.2	1.2	6'	4	208	1.69	1.35	3'	4	399	1.12	1.85
	8'	219	1.5	1.5	8'	5	106	2.5	1.81	4'	6	208	1.34	2.54
	10'	140	1.9	1.9	10'	7	77.2	2.89	2.42	5'	7	150	1.57	2.92
	12'	97.5	2.3	2.3	12'	8	52.1	3.48	2.91	6'	8	99.9	1.98	3.6
MXTG2-RNRR302WL1-CR 3000K 24° Narrow Flood	6'	129	2.5	2.5	6'	4	73.6	3.33	2.92	3'	4	146	1.95	3.22
	8'	72.7	3.3	3.3	8'	5	42.4	4.34	3.69	4'	5	82.8	2.64	4.19
	10'	46.6	4.1	4.1	10'	6	27.1	5.45	4.62	5'	6	52.1	3.35	5.28
	12'	32.3	4.9	4.9	12'	7	18.6	6.59	5.63	6'	8	36.5	3.92	6.28
MXTG2-RNRR302WL1-CR 3000K 36° Flood	6'	66.5	3.8	3.8	6'	3	44.7	4.37	3.86	3'	3	84.5	2.9	4.05
	8'	37.4	5.1	5.1	8'	4	25.2	5.76	5.24	4'	4	47.5	3.66	5.45
	10'	23.9	6.4	6.4	10'	5	16.1	7.22	6.55	5'	5	30.4	4.76	6.78
	12'	16.6	7.7	7.7	12'	6	11.2	8.66	7.78	6'	7	21.1	5.6	8.14
MXTG2-RNRR302WL1-CR 3000K 50° Wide Flood	6'	31.3	5.4	5.4	6'	3	23.5	5.27	5.06	3'	3	45.8	3.46	4.47
	8'	17.6	7.2	7.2	8'	3	13.5	6.83	6.6	4'	4	25.8	4.66	5.89
	10'	11.3	9	9	10'	4	8.7	8.48	8.23	5'	5	16.5	5.78	7.38
	12'	7.8	10.8	10.8	12'	5	6.1	10.17	9.89	6'	6	11.5	6.97	8.82

JOB NAME		CATALOG NUMBER	
NOTES		TYPE	

MXTG2-RNRR302L2-CR

Report #: ILL-01262016-27 (12)
 ILL-01262016-30 (24)
 ILL-01262016-33 (36)
 ILL-02102016-06 (50)

MXTG2-RNRR302

Ceiling Thickness Multipliers:
 5/8" Thickness (x 1.00)
 1" Thickness (x 0.87)
 2" Thickness (x 0.73)

CCT MULTIPLIERS:

	82 CRI	92 CRI
2700K	(x 0.93)	(x 0.76)
3000K	(x 1.00)	(x 0.87)
3500K	(x 1.00)	(x 0.87)
4100K	(x 1.00)	(x 0.87)

LENS MULTIPLIERS:

Solite	(x 0.92)
Clear	(x 1.00)
Frosted	(x 0.92)

EMERGENCY MULTIPLIER:

7W Emergency	(x 0.40)
12W Emergency	(x 0.68)

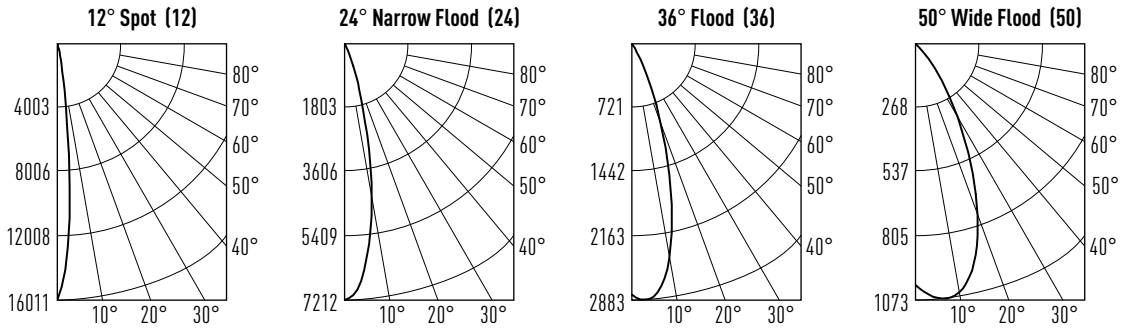

Watts: 20.4
 Lumens: 996
 LPW: 49
 CCT: 3000K

Watts: 20.4
 Lumens: 1147
 LPW: 56
 CCT: 3000K

Watts: 20.4
 Lumens: 1166
 LPW: 57
 CCT: 3000K

Watts: 20.8
 Lumens: 910
 LPW: 44
 CCT: 3000K

Candelas at Nadir

Degree	Candela
0°	16011
5°	10003
15°	605
25°	130
35°	51
45°	7

Candelas at Nadir

Degree	Candela
0°	7212
5°	9072
15°	1772
25°	203
35°	25
45°	3

Candelas at Nadir

Degree	Candela
0°	2874
5°	2843
15°	1908
25°	616
35°	125
45°	11

Candelas at Nadir

Degree	Candela
0°	1060
5°	1071
15°	990
25°	619
35°	263
45°	81

APPLICATION DATA:

W and **L** are the outer points where the candle power drops to 50% of maximum. **FC** are the initial footcandles at the center of the beam.

- W** Beam width
- L** Beam length
- C** Distance to center of beam
- D** Distance
- FC** Footcandles

Illuminated width & length are based upon point at which illuminance falls to 50% of center illuminance. Recommended spacing is based upon uniform illuminance aiming angle is the angle between the lamp axis and the perpendicular to the illuminated plane.

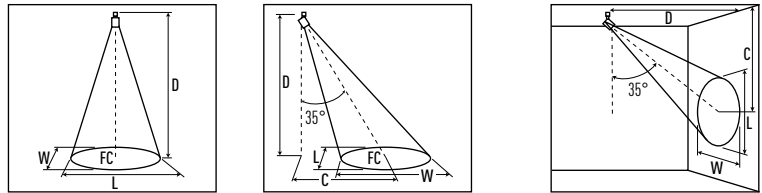

	0° HORIZONTAL				35° HORIZONTAL				35° VERTICAL					
	D	FC	W	L	D	C	FC	W	L	D	C	FC	W	L
MXTG2-RNRR302WL2-CR 3000K 12° Spot	6'	445	1.3	1.3	6'	4	252	1.78	1.37	3'	4	497	1.11	1.89
	8'	250	1.7	1.7	8'	5	137	2.48	1.77	4'	6	252	1.38	2.63
	10'	160	2.1	2.1	10'	7	88	3.16	2.68	5'	7	175	1.67	3.14
	12'	111	2.5	2.5	12'	8	63	3.64	3.05	6'	8	124	2.04	3.7
MXTG2-RNRR302WL2-CR 3000K 24° Narrow Flood	6'	200	2.3	2.3	6'	4	113	3.12	2.71	3'	4	224	1.79	3.04
	8'	113	3	3	8'	5	64.3	4.07	3.46	4'	5	125	2.5	4.03
	10'	72.1	3.8	3.8	10'	6	40.6	5.14	4.38	5'	7	78.8	3.16	5
	12'	50.1	4.5	4.5	12'	8	28.3	6.14	5.3	6'	8	56	3.66	5.89
MXTG2-RNRR302WL2-CR 3000K 36° Flood	6'	79.8	3.9	3.9	6'	3	53.8	4.38	3.89	3'	3	102	2.91	4.05
	8'	44.9	5.2	5.2	8'	4	30.3	5.78	5.28	4'	4	57.2	3.7	5.46
	10'	28.7	6.5	6.5	10'	5	19.4	7.25	6.59	5'	5	36.6	4.79	6.8
	12'	20	7.8	7.8	12'	6	13.4	8.66	7.84	6'	6	25.4	5.63	8.13
MXTG2-RNRR302WL2-CR 3000K 50° Wide Flood	6'	29.4	6	6	6'	2	22.5	5.27	5.31	3'	3	41.8	3.74	4.56
	8'	16.6	8	8	8'	3	12.9	6.9	7.01	4'	4	23.5	5.01	6.01
	10'	10.6	10	10	10'	4	8.2	8.61	8.76	5'	5	15	6.31	7.57
	12'	7.4	12	12	12'	5	5.7	10.33	10.52	6'	6	10.4	7.56	9.04

JOB NAME		CATALOG NUMBER	
NOTES		TYPE	

MXTG2-RNRR302L3-CR

Report #: ILL-01262016-12 (12)
 ILL-01262016-09 (24)
 ILL-01262016-03 (36)
 ILL-02102016-05 (50)

MXTG2-RNRR302

Ceiling Thickness Multipliers:
 5/8" Thickness (x 1.00)
 1" Thickness (x 0.87)
 2" Thickness (x 0.73)

CCT MULTIPLIERS:

	82 CRI	92 CRI
2700K	(x 0.93)	(x 0.76)
3000K	(x 1.00)	(x 0.87)
3500K	(x 1.00)	(x 0.87)
4100K	(x 1.00)	(x 0.87)

LENS MULTIPLIERS:

Solite	(x 0.92)
Clear	(x 1.00)
Frosted	(x 0.92)

EMERGENCY MULTIPLIER:

7W Emergency	(x 0.35)
12W Emergency	(x 0.59)

12° Spot (12)

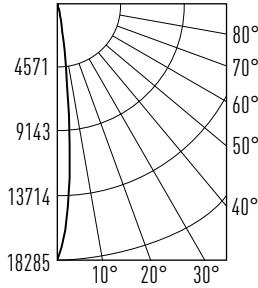

Watts: 26.3
 Lumens: 1162
 LPW: 44
 CCT: 3000K

24° Narrow Flood (24)

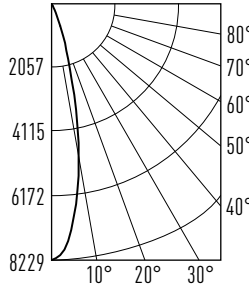

Watts: 26.3
 Lumens: 1398
 LPW: 53
 CCT: 3000K

36° Flood (36)

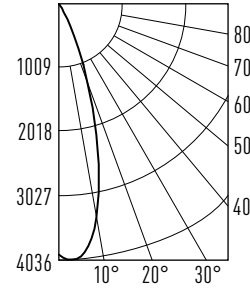

Watts: 26.3
 Lumens: 1372
 LPW: 52
 CCT: 3000K

50° Wide Flood (50)

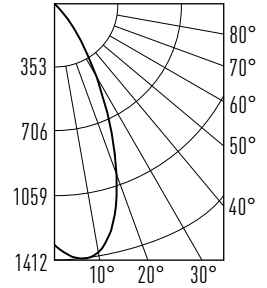

Watts: 26.6
 Lumens: 1196
 LPW: 45
 CCT: 3000K

Candelas at Nadir

Degree	Candela
0°	18285
5°	11742
15°	655
25°	143
35°	55
45°	9

Candelas at Nadir

Degree	Candela
0°	8229
5°	7144
15°	2207
25°	256
35°	29
45°	4

Candelas at Nadir

Degree	Candela
0°	4009
5°	3949
15°	2290
25°	625
35°	111
45°	10

Candelas at Nadir

Degree	Candela
0°	1396
5°	1410
15°	1301
25°	813
35°	345
45°	107

APPLICATION DATA:

W and L are the outer points where the candle power drops to 50% of maximum. FC are the initial footcandles at the center of the beam.

- W Beam width
- L Beam length
- C Distance to center of beam
- D Distance
- FC Footcandles

Illuminated width & length are based upon point at which illuminance falls to 50% of center illuminance. Recommended spacing is based upon uniform illuminance aiming angle is the angle between the lamp axis and the perpendicular to the illuminated plane.

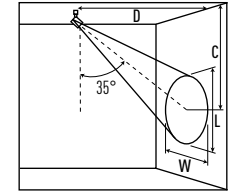
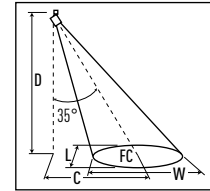
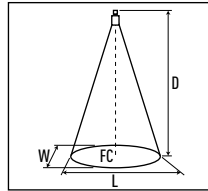

	0° HORIZONTAL				35° HORIZONTAL				35° VERTICAL					
	D	FC	W	L	D	C	FC	W	L	D	C	FC	W	L
MXTG2-RNRR302WL3-CR 3000K 12° Spot	6'	508	1.3	1.3	6'	4	286	1.83	1.41	3'	4	557	1.11	1.92
	8'	286	1.7	1.7	8'	5	157	2.5	1.84	4'	6	286	1.41	2.7
	10'	183	2.2	2.2	10'	7	101	3.19	2.72	5'	7	200	1.72	3.2
	12'	127	2.6	2.6	12'	8	71.5	3.74	3.11	6'	8	139	2.19	3.81
MXTG2-RNRR302WL3-CR 3000K 24° Narrow Flood	6'	229	2.4	2.4	6'	4	130	3.22	2.8	3'	4	257	1.88	3.13
	8'	129	3.2	3.2	8'	5	74.6	4.18	3.57	4'	5	145	2.56	4.1
	10'	82.3	4	4	10'	6	47.1	5.3	4.53	5'	6	90.8	3.28	5.15
	12'	57.1	4.7	4.7	12'	8	32.5	6.39	5.5	6'	8	64.2	3.8	6.08
MXTG2-RNRR302WL3-CR 3000K 36° Flood	6'	111	3.5	3.5	6'	3	71.5	4.17	3.64	3'	3	131	2.8	4.02
	8'	62.6	4.7	4.7	8'	4	40.2	5.52	4.93	4'	5	76.2	3.46	5.24
	10'	40.1	5.8	5.8	10'	5	25.7	6.89	6.09	5'	6	49.8	4.37	6.43
	12'	27.8	7	7	12'	6	17.9	8.27	7.34	6'	7	34.8	5.16	7.65
MXTG2-RNRR302WL3-CR 3000K 50° Wide Flood	6'	38.8	6	6	6'	2	29.5	5.28	5.33	3'	3	55	3.74	4.55
	8'	21.8	8	8	8'	3	16.9	6.92	7.01	4'	4	30.9	5.01	6
	10'	14	10	10	10'	4	10.8	8.62	8.74	5'	5	19.8	6.3	7.57
	12'	9.7	12	12	12'	5	7.5	10.36	10.54	6'	6	13.7	7.53	9.01