

MXG2ARTR

3.5" MX G2 LED Lensed Pinhole - Wet Location

JOB NAME		CATALOG NUMBER	
NOTES		TYPE	

ELECTRICAL DATA

LED Light Engine	System Wattage *	CCT / CRI	Delivered Lumens **	Lumens Per Watt
L0	10W	3000K / 82 CRI	800lm	80
L1	16W	3000K / 82 CRI	1100lm	69
L2	20W	3000K / 82 CRI	1350lm	68
L3	26W	3000K / 82 CRI	1500lm	58

*System Wattage include driver and LED Module consumption. **Delivered lumens will vary depending on trim, CCT, CRI, optic and ceiling thickness

FEATURES

- Multiple architectural trim options
- High center beam spot up to 21,600 CBCP
- Dedicated 9° with field changeable 12°, 24°, 36° & 50° optics

LED LIGHT ENGINE

- 92 CRI & 82 CRI in 2700K, 3000K, 3500K or 4100K with ZSDCM binning
- >50,000 hours L70 (rated life at 70% output)

ELECTRICAL SYSTEM

- (Non-IC) Dedicated voltage options of 120V or 277V. Must be specified in catalog code.
- (-IC/-CP) Universal 120V/277V input
- This product complies with IEEE C62.41 for surge endurance up to 2.5KV. Additional surge protection recommended. Damage from power surge is not covered by warranty.

DIMMING

- 0-10V Dimming 1%
- Forward/reverse dimming 1% (120V only)
- EldoLED 0-10V 0.1% or 1%
- Lutron® LDE1 Hi-Lume 1% EcoSystem LED driver with Soft-on, Fade-to-Black dimming technology
- Lutron® LTEA2W Hi-Lume 1% 2-Wire LED driver (120V forward phase only)
- DMX512 RDM 0.1%

HOUSING

- Heavy duty black powder coated 18 gauge steel frame
- Standard housing accommodates 5/8" ceiling thickness
- Extended collar options available for ceilings up to 1" or 2" thick, must specify either EC1 or EC2 (EC1/EC2 Not available with Chicago Plenum)

TRIM SPECIFICATION

Aiming with locking 35° vertical and 360° horizontal adjustment. High quality trims are die-cast using A380 aluminum with durable powder coat available in multiple finishes, black interior standard. Trim is available with solite, clear tempered or frosted lens, must specify.

INSTALLATION

Housing types include IC Air-Tight, CCEA (Chicago Plenum), or Non-IC Rated (must specify). Non-IC rated housings must be kept at a minimum of 3" away from insulation. Butterfly brackets are compatible with C-channel, adjustable bar hangers (14"-25") and EMT. C-channel is recommended for T-bar ceilings. Bar hangers must be ordered separately. Max. ambient temperature: 95°F (35°C).

EMERGENCY BACKUP

Remote test switch included. External battery operates LED load at a minimum of 400 to 650 lumens for 90 minutes, depending on backup wattage selected. See trim multipliers for detailed performance. Servicing requires above ceiling access. (EM not available with Chicago Plenum)

LISTING / WARRANTY

- 5-Year Intense LED Limited Warranty
- ETL listed to US and Canadian standards for wet locations
- (-IC/-CP Only) Air-Tight Certified ASTM E283
- (-IC/-CP Only) ETL listed for direct contact w/insulation
- (-CP Only) CCEA Chicago Plenum

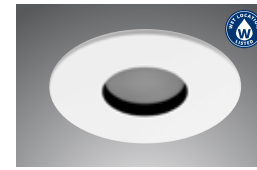

MXTG2-RTRR308
(1/2" Regress with Lens)

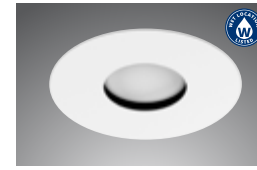
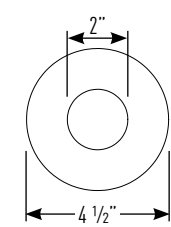
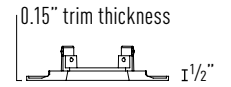

MXTG2-RFRR308
(1/2" Flat Mount with Lens)

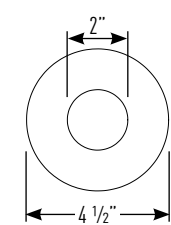

Housing dimensions are on Page 2

Housing Part Number (Example: MXG2ARTR-ICL1)

Housing	Installation Type	Ceiling Thickness	Wattage	Dimming	Voltage	Options
MXG2ARTR	-NC (Non-IC)	blank (5/8")	L0 (10W)	blank (Non-Dimming)	blank (Non-IC: 120V	1100 (C-Channel Bar Hangers)
	-IC (Air-Tight IC)	EC1 ¹ (1")	L1 (16W)	DELV ³ (Phase Dimming)	-IC/-CP: 120V/277V)	1200 (Flat Bar Hangers)
	-CP (Chicago Plenum)	EC2 ¹ (2")	L2 (20W)	D101 (0-10V Dimming 1%)	27 (277V Non-IC Only, for -IC/-CP housing options use blank)	1400 (Wood Joist Bar Hangers)
			L3 ² (26W)	ED10V1 ⁴ (eldoLED 0-10V 1%)		EM7 ⁷ (7W Emergency Backup IOTA Part #ILB-CP07-A)
				ED10V01 ⁴ (eldoLED 0-10V 0.1%)		EM12 ^{7,8} (12W Emergency Backup IOTA Part #ILB-CP12-A)
				LUT ⁵ (Lutron® LDE1 EcoSystem 1%)		
				LUT2 ³ (Lutron® LTEA2W 2-Wire 1%)		
				DMXR ⁶ (DMX512 RDM 0.1%)		

Trim Part Number (Example: MXTG2-RTRR308WL13024-SL)

Trim	Finish	Wattage	CCT / CRI	Optic	Lens
MXTG2-RTRR308 (1/2" Regress)	B (Black)	L0 (10W)	27 (2700K / 82 CRI)	09° (9° Narrow Spot)	-SL (Solite)
	W (White)	L1 (16W)	279 (2700K / 92 CRI)	12 (12° Spot)	-CR (Clear Tempered)
MXTG2-RFRR308 (1/2" Flat Mount)	SN (Satin Nickel)	L2 (20W)	30 (3000K / 82 CRI)	24 (24° Narrow Flood)	-FR (Frosted)
	AB (Antique Bronze)	L3 ² (26W)	309 (3000K / 92 CRI)	36 (36° Flood)	
			35 (3500K / 82 CRI)	50 (50° Wide Flood)	
	WH (Wheat)		359 (3500K / 92 CRI)		
			41 (4100K / 82 CRI)		
		419 (4100K / 92 CRI)			

Notes:

- EC1/EC2 not available with (-CP) Chicago Plenum
- L3 available with Non-IC housings only
- Available in 120V only
- Not Available in L3
- Not Available in L2 & L3
- DMX512 RDM not available in L0 & L1
- Access above ceiling required; not available with (-CP) Chicago Plenum
- Not available in L0
- 9° NS available in 279 with L0 or L1 Only

MX ADJUSTABLE L/M-11221 P-19

INTENSE LIGHTING | 3340 E La Palma Ave, Anaheim, CA 92806 | tel 714 630-9877 | fax 714 630-9883

For Intense Lighting's limited product warranty, go to www.intenselighting.com. For a printed copy of the warranty, you may call 800 961-5321.

© 2021 Intense Lighting, LLC. All rights reserved. Note: This document is subject to change without notice.

intense[®] | a LEVITON[®] company
LIGHTING

MXG2ARTR

3.5" MX G2 LED Lensed Pinhole - Wet Location

JOB NAME		CATALOG NUMBER	
NOTES		TYPE	

NON-IC & AIR TIGHT IC DIMENSIONS

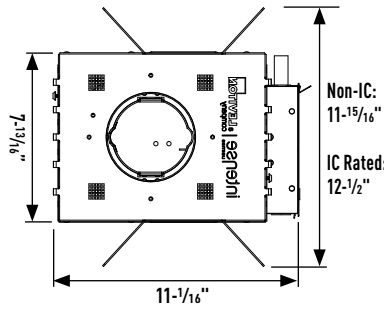
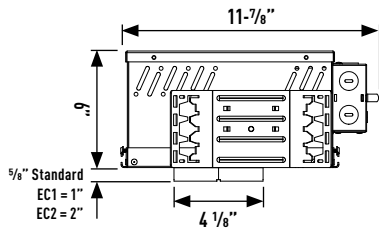

Ceiling Cut Out: 4 1/8"

Plaster Frame Accommodation

Collar Type	Standard	EC1	EC2
Max Ceiling Thickness	Up-to 5/8"	Up-to 1"	Up-to 2"

CCEA CHICAGO PLENUM DIMENSIONS

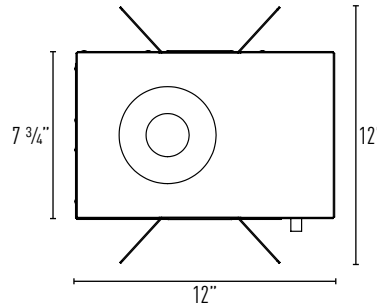
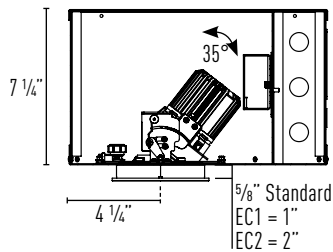

Ceiling Cut Out: 4 1/8"

Plaster Frame Accommodation

Collar Type	Standard	EC1	EC2
Max Ceiling Thickness	Up-to 5/8"	Up-to 1"	Up-to 2"

OPTICS REPLACEMENT

1. Rotate release cap by turning counter clockwise.
2. Install accessories into accessory holder and replace accessory holder's retaining clip.
3. Place accessory holder and accessory flush against optic and replace release cap.

Optics

- IP-OP4712 (12° Spot)
- IP-OP4724 (24° Narrow Flood)
- IP-OP4736 (36° Flood)
- IP-OP4750 (50° Wide Flood)

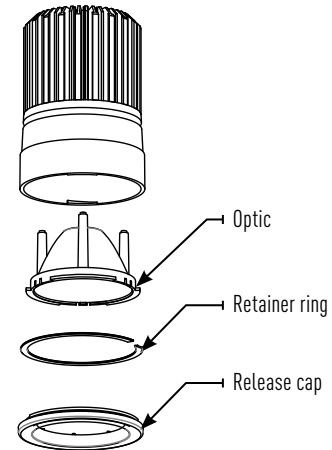

JOB NAME		CATALOG NUMBER	
NOTES		TYPE	

MXTG2-RTRR308L0-CR

Report #: ILL-01262016-38 (12)
 ILL-02082016-11 (24)
 ILL-01262016-44 (36)
 ILL-01262016-47 (50)

MXTG2-RTRR308

Ceiling Thickness Multipliers:
 5/8" Thickness (x 1.00)
 1" Thickness (x 0.86)
 2" Thickness (x 0.67)

MXTG2-RFRR308

Ceiling Thickness Multipliers:
 5/8" Thickness (x 1.00)
 1" Thickness (x 0.86)
 2" Thickness (x 0.67)

CCT MULTIPLIERS:

	82 CRI	92 CRI
2700K	(x 0.93)	(x 0.76)
3000K	(x 1.00)	(x 0.87)
3500K	(x 1.00)	(x 0.87)
4100K	(x 1.00)	(x 0.87)

LENS MULTIPLIERS:

Solite	(x 0.92)
Clear	(x 1.00)
Frosted	(x 0.92)

EMERGENCY MULTIPLIER:

7W Emergency (x 0.70)

12° Spot (12)

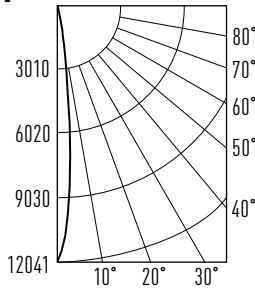

Watts: 10
 Lumens: 689
 LPW: 69
 CCT: 3000K

Candelas at Nadir

Degree	Candela
0°	12041
5°	7036
15°	498
25°	47
35°	8
45°	2

24° Narrow Flood (24)

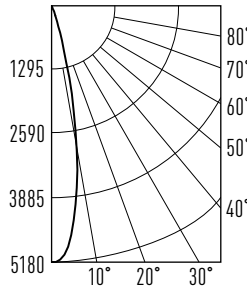

Watts: 10
 Lumens: 793
 LPW: 79
 CCT: 3000K

Candelas at Nadir

Degree	Candela
0°	5177
5°	4646
15°	1193
25°	88
35°	8
45°	3

36° Flood (36)

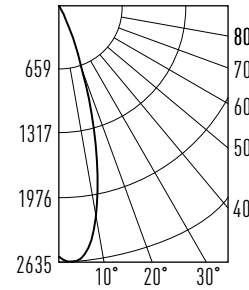

Watts: 10
 Lumens: 805
 LPW: 81
 CCT: 3000K

Candelas at Nadir

Degree	Candela
0°	2576
5°	2608
15°	1477
25°	298
35°	30
45°	2

50° Wide Flood (50)

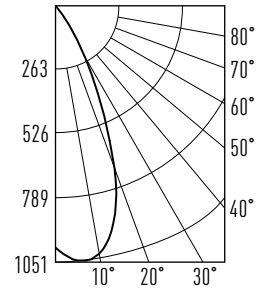

Watts: 10
 Lumens: 642
 LPW: 64
 CCT: 3000K

Candelas at Nadir

Degree	Candela
0°	991
5°	1047
15°	921
25°	446
35°	118
45°	7

APPLICATION DATA:

W and **L** are the outer points where the candle power drops to 50% of maximum. **FC** are the initial footcandles at the center of the beam.

W Beam width
L Beam length
C Distance to center of beam
D Distance
FC Footcandles

Illuminated width & length are based upon point at which illuminance falls to 50% of center illuminance. Recommended spacing is based upon uniform illuminance aiming angle is the angle between the lamp axis and the perpendicular to the illuminated plane.

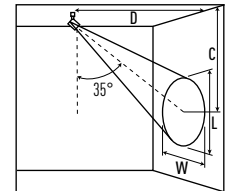
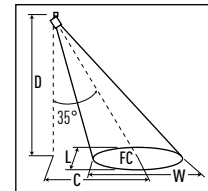
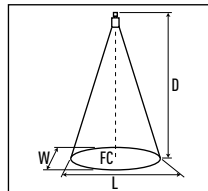

	0° HORIZONTAL				35° HORIZONTAL				35° VERTICAL					
	D	FC	W	L	D	C	FC	W	L	D	C	FC	W	L
MXTG2-RTRR308L0-CR 3000K 12° Spot	6'	334	1.2	1.2	6'	4	181	1.74	1.38	3'	4	349	1.13	1.9
	8'	188	1.6	1.6	8'	5	93.8	2.54	1.84	4'	6	181	1.38	2.59
	10'	120	2	2	10'	7	66.2	3	2.54	5'	7	129	1.63	3.04
	12'	83.6	2.4	2.4	12'	8	45.2	3.58	3	6'	8	87.2	2.07	3.7
MXTG2-RTRR308L0-CR 3000K 24° Narrow Flood	6'	144	2.3	2.3	6'	4	82.7	3.17	2.77	3'	4	165	1.79	3.11
	8'	80.9	3.1	3.1	8'	5	48	4.08	3.45	4'	5	94	2.5	4.02
	10'	51.8	3.9	3.9	10'	6	30.8	5.09	4.37	5'	6	59.1	3.16	5.05
	12'	35.9	4.6	4.6	12'	7	21.1	6.17	5.3	6'	8	41.1	3.71	6.02
MXTG2-RTRR308L0-CR 3000K 36° Flood	6'	71.6	3.4	3.4	6'	3	47.4	4.06	3.57	3'	3	86.8	2.74	3.96
	8'	40.3	4.5	4.5	8'	4	26.7	5.38	4.83	4'	5	50.1	3.42	5.18
	10'	25.8	5.7	5.7	10'	5	17.1	6.68	5.97	5'	6	32.9	4.34	6.37
	12'	17.9	6.8	6.8	12'	6	11.9	8.05	7.2	6'	7	23.1	5.06	7.55
MXTG2-RTRR308L0-CR 3000K 50° Wide Flood	6'	27.5	5.1	5.1	6'	3	20.8	5.02	4.91	3'	3	40.5	3.35	4.38
	8'	15.5	6.7	6.7	8'	3	12	6.5	6.49	4'	4	22.8	4.58	5.78
	10'	9.9	8.4	8.4	10'	4	7.8	8.06	8.1	5'	5	14.6	5.75	7.18
	12'	6.9	10.1	10.1	12'	5	5.4	9.64	9.67	6'	6	10.1	6.89	8.62

JOB NAME		CATALOG NUMBER	
NOTES		TYPE	

MXTG2-RTRR308L1-CR

Report #: ILL-01262016-14 (12)
 ILL-02082016-09 (24)
 ILL-01262016-20 (36)
 ILL-01262016-23 (50)

MXTG2-RTRR308

Ceiling Thickness Multipliers:
 5/8" Thickness (x 1.00)
 1" Thickness (x 0.86)
 2" Thickness (x 0.67)

MXTG2-RFRR308

Ceiling Thickness Multipliers:
 5/8" Thickness (x 1.00)
 1" Thickness (x 0.86)
 2" Thickness (x 0.67)

CCT MULTIPLIERS:

	82 CRI	92 CRI
2700K	(x 0.93)	(x 0.76)
3000K	(x 1.00)	(x 0.87)
3500K	(x 1.00)	(x 0.87)
4100K	(x 1.00)	(x 0.87)

LENS MULTIPLIERS:

Solite	(x 0.92)
Clear	(x 1.00)
Frosted	(x 0.92)

EMERGENCY MULTIPLIER:

7W Emergency	(x 0.50)
12W Emergency	(x 0.85)

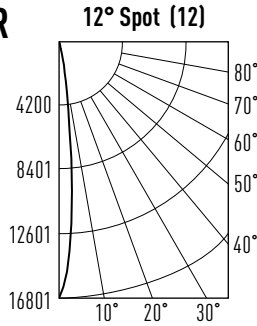

Watts: 15.6
 Lumens: 946
 LPW: 61
 CCT: 3000K

Candelas at Nadir

Degree	Candela
0°	16801
5°	9647
15°	682
25°	65
35°	12
45°	3

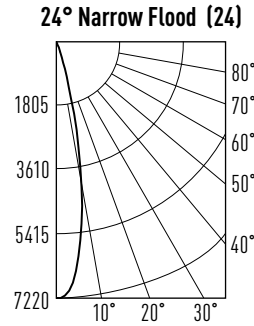

Watts: 15.6
 Lumens: 1107
 LPW: 71
 CCT: 3000K

Candelas at Nadir

Degree	Candela
0°	7216
5°	6483
15°	1664
25°	123
35°	11
45°	4

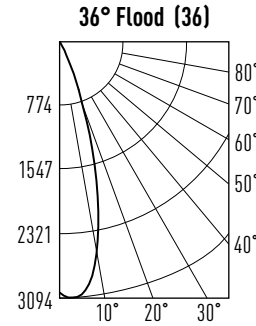

Watts: 15.6
 Lumens: 1144
 LPW: 73
 CCT: 3000K

Candelas at Nadir

Degree	Candela
0°	3064
5°	3052
15°	2016
25°	540
35°	76
45°	3

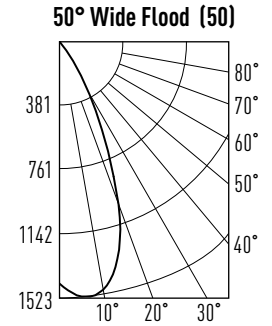

Watts: 15.6
 Lumens: 898
 LPW: 58
 CCT: 3000K

Candelas at Nadir

Degree	Candela
0°	1441
5°	1519
15°	1307
25°	613
35°	158
45°	9

APPLICATION DATA:

W and **L** are the outer points where the candle power drops to 50% of maximum. **FC** are the initial foot candles at the center of the beam.

W Beam width
L Beam length
C Distance to center of beam
D Distance
FC Footcandles

Illuminated width & length are based upon point at which illuminance falls to 50% of center illuminance. Recommended spacing is based upon uniform illuminance aiming angle is the angle between the lamp axis and the perpendicular to the illuminated plane.

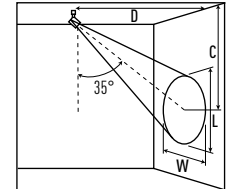
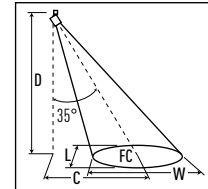
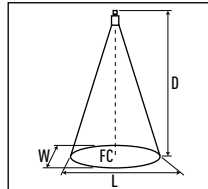

	0° HORIZONTAL				35° HORIZONTAL				35° VERTICAL					
	D	FC	W	L	D	C	FC	W	L	D	C	FC	W	L
MXTG2-RTRR308L1-CR 3000K 12° Spot	6'	467	1.2	1.2	6'	4	252	1.72	1.37	3'	4	484	1.13	1.88
	8'	263	1.6	1.6	8'	5	130	2.51	1.82	4'	6	252	1.37	2.58
	10'	168	2	2	10'	7	92.4	2.97	2.5	5'	7	180	1.62	2.99
	12'	117	2.4	2.4	12'	8	62.9	3.54	2.97	6'	8	121	2.04	3.69
MXTG2-RTRR308L1-CR 3000K 24° Narrow Flood	6'	200	2.3	2.3	6'	4	115	3.17	2.78	3'	4	229	1.79	3.11
	8'	113	3.1	3.1	8'	5	66.9	4.09	3.44	4'	5	131	2.5	4.03
	10'	72.2	3.9	3.9	10'	6	42.9	5.09	4.37	5'	6	82.4	3.16	5.04
	12'	50.1	4.6	4.6	12'	8	29.4	6.18	5.31	6'	8	57.3	3.72	6.04
MXTG2-RTRR308L1-CR 3000K 36° Flood	6'	85.1	3.8	3.8	6'	3	57.5	4.31	3.86	3'	3	109	2.87	4.01
	8'	47.9	5.1	5.1	8'	4	32.3	5.69	5.22	4'	4	61.1	3.66	5.42
	10'	30.6	6.3	6.3	10'	5	20.7	7.13	6.51	5'	5	39.1	4.72	6.73
	12'	21.3	7.6	7.6	12'	6	14.4	8.55	7.77	6'	7	27.2	5.58	8.04
MXTG2-RTRR308L1-CR 3000K 50° Wide Flood	6'	40	4.9	4.9	6'	3	30	4.95	4.8	3'	3	58.4	3.3	4.37
	8'	22.5	6.6	6.6	8'	3	17.1	6.84	6.44	4'	4	32.8	4.49	5.73
	10'	14.4	8.2	8.2	10'	4	11.1	6.54	7.98	5'	5	21	5.63	7.17
	12'	10	9.9	9.9	12'	5	7.7	9.54	9.49	6'	6	14.6	6.75	8.59

JOB NAME		CATALOG NUMBER	
NOTES		TYPE	

MXTG2-RTRR308L2-CR

Report #: ILL-01262016-26 (12)
 ILL-02082016-06 (24)
 ILL-01262016-32 (36)
 ILL-02082016-05 (50)

MXTG2-RTRR308

Ceiling Thickness Multipliers:
 5/8" Thickness (x 1.00)
 1" Thickness (x 0.86)
 2" Thickness (x 0.67)

MXTG2-RFRR308

Ceiling Thickness Multipliers:
 5/8" Thickness (x 1.00)
 1" Thickness (x 0.86)
 2" Thickness (x 0.67)

CCT MULTIPLIERS:

	82 CRI	92 CRI
2700K	(x 0.93)	(x 0.76)
3000K	(x 1.00)	(x 0.87)
3500K	(x 1.00)	(x 0.87)
4100K	(x 1.00)	(x 0.87)

LENS MULTIPLIERS:

Solite	(x 0.92)
Clear	(x 1.00)
Frosted	(x 0.92)

EMERGENCY MULTIPLIER:

7W Emergency	(x 0.40)
12W Emergency	(x 0.68)

12° Spot (12)

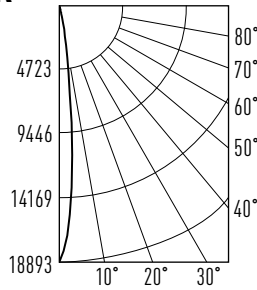

Watts: 20.4
 Lumens: 1164
 LPW: 57
 CCT: 3000K

24° Narrow Flood (24)

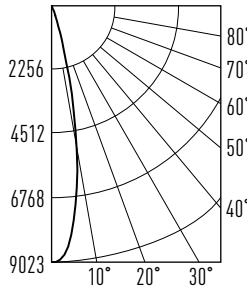

Watts: 20.8
 Lumens: 1354
 LPW: 65
 CCT: 3000K

36° Flood (36)

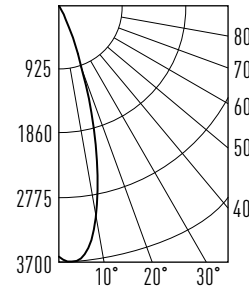

Watts: 20.4
 Lumens: 1377
 LPW: 68
 CCT: 3000K

50° Wide Flood (50)

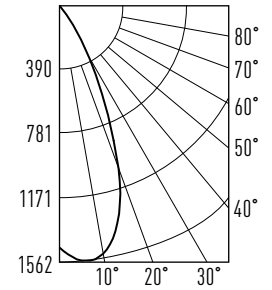

Watts: 20.8
 Lumens: 1095
 LPW: 53
 CCT: 3000K

Candelas at Nadir

Degree	Candela
0°	18893
5°	12317
15°	737
25°	93
35°	17
45°	4

Candelas at Nadir

Degree	Candela
0°	8971
5°	8191
15°	2027
25°	127
35°	14
45°	5

Candelas at Nadir

Degree	Candela
0°	3694
5°	3642
15°	2430
25°	646
35°	95
45°	4

Candelas at Nadir

Degree	Candela
0°	1440
5°	1522
15°	1476
25°	802
35°	244
45°	16

APPLICATION DATA:

W and **L** are the outer points where the candle power drops to 50% of maximum. **FC** are the initial foot candles at the center of the beam.

- W** Beam width
- L** Beam length
- C** Distance to center of beam
- D** Distance
- FC** Footcandles

Illuminated width & length are based upon point at which illuminance falls to 50% of center illuminance. Recommended spacing is based upon uniform illuminance aiming angle is the angle between the lamp axis and the perpendicular to the illuminated plane.

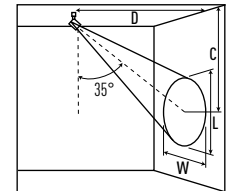
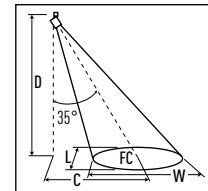
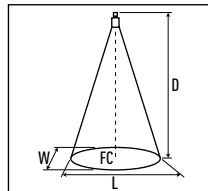

	0° HORIZONTAL				35° HORIZONTAL				35° VERTICAL					
	D	FC	W	L	D	C	FC	W	L	D	C	FC	W	L
MXTG2-RTRR308L2-CR 3000K 12° Spot	6'	525	1.3	1.3	6'	4	300	1.84	1.41	3'	4	595	1.11	1.93
	8'	295	1.7	1.7	8'	5	166	2.51	1.81	4'	5	303	1.4	2.66
	10'	189	2.2	2.2	10'	7	104	3.26	2.79	5'	7	208	1.73	3.22
	12'	131	2.6	2.6	12'	8	75	3.75	3.14	6'	8	149	2.11	3.77
MXTG2-RTRR308L2-CR 3000K 24° Narrow Flood	6'	249	2.3	2.3	6'	4	144	3.15	2.75	3'	4	288	1.78	3.09
	8'	140	3.1	3.1	8'	5	84.3	4.06	3.44	4'	5	165	2.48	3.98
	10'	89.7	3.9	3.9	10'	6	54.2	5.05	4.33	5'	6	104	3.14	4.99
	12'	62.3	4.6	4.6	12'	7	37.1	6.1	5.26	6'	8	71.9	3.7	6.01
MXTG2-RTRR308L2-CR 3000K 36° Flood	6'	103	3.8	3.8	6'	3	68.9	4.31	3.88	3'	3	130	2.86	4
	8'	57.7	5.1	5.1	8'	4	38.7	5.69	5.25	4'	4	73.2	3.69	5.43
	10'	36.9	6.4	6.4	10'	5	24.8	7.15	6.54	5'	5	46.8	4.74	6.74
	12'	25.7	7.7	7.7	12'	6	17.2	8.55	7.81	6'	6	32.5	5.62	8.06
MXTG2-RTRR308L2-CR 3000K 50° Wide Flood	6'	40	5.2	5.2	6'	2	33.5	4.89	5.08	3'	3	61.3	3.63	4.44
	8'	22.5	6.9	6.9	8'	3	19.1	6.35	6.75	4'	4	34.5	4.91	5.84
	10'	14.4	8.6	8.6	10'	4	12.2	7.96	8.53	5'	5	22.1	6.27	7.34
	12'	10	10.4	10.4	12'	5	8.4	9.64	10.03	6'	5	15.4	7.4	8.73

JOB NAME		CATALOG NUMBER	
NOTES		TYPE	

MXTG2-RTRR308L3-CR

Report #: ILL-01262016-11 (12)
 ILL-02082016-02 (24)
 ILL-01262016-02 (36)
 ILL-02082016-01 (50)

MXTG2-RTRR308

Ceiling Thickness Multipliers:
 5/8" Thickness (x 1.00)
 1" Thickness (x 0.86)
 2" Thickness (x 0.67)

MXTG2-RFRR308

Ceiling Thickness Multipliers:
 5/8" Thickness (x 1.00)
 1" Thickness (x 0.86)
 2" Thickness (x 0.67)

CCT MULTIPLIERS:

	82 CRI	92 CRI
2700K	(x 0.93)	(x 0.76)
3000K	(x 1.00)	(x 0.87)
3500K	(x 1.00)	(x 0.87)
4100K	(x 1.00)	(x 0.87)

LENS MULTIPLIERS:

Solite	(x 0.92)
Clear	(x 1.00)
Frosted	(x 0.92)

EMERGENCY MULTIPLIER:

7W Emergency	(x 0.35)
12W Emergency	(x 0.59)

12° Spot (12)

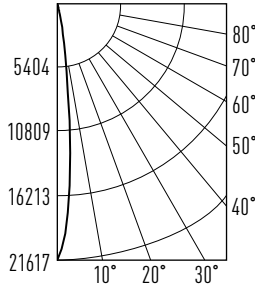

Watts: 26.3
 Lumens: 1342
 LPW: 51
 CCT: 3000K

Candelas at Nadir

Degree	Candela
0°	21617
5°	14174
15°	798
25°	98
35°	20
45°	5

24° Narrow Flood (24)

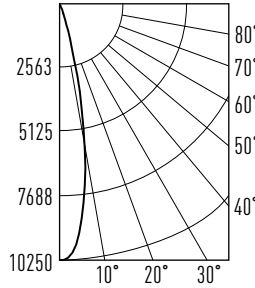

Watts: 26.3
 Lumens: 1540
 LPW: 59
 CCT: 3000K

Candelas at Nadir

Degree	Candela
0°	10193
5°	9303
15°	2304
25°	144
35°	16
45°	5

36° Flood (36)

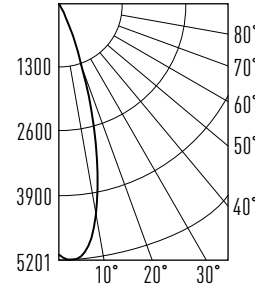

Watts: 26.4
 Lumens: 1546
 LPW: 59
 CCT: 3000K

Candelas at Nadir

Degree	Candela
0°	5172
5°	5082
15°	2760
25°	563
35°	75
45°	5

50° Wide Flood (50)

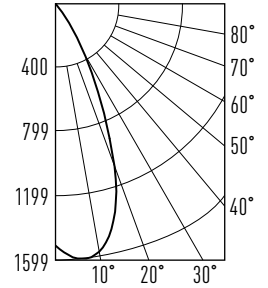

Watts: 26.3
 Lumens: 1143
 LPW: 43
 CCT: 3000K

Candelas at Nadir

Degree	Candela
0°	1599
5°	1557
15°	1411
25°	836
35°	306
45°	27

APPLICATION DATA:

W and **L** are the outer points where the candle power drops to 50% of maximum. **FC** are the initial footcandles at the center of the beam.

W Beam width
L Beam length
C Distance to center of beam
D Distance
FC Footcandles

Illuminated width & length are based upon point at which illuminance falls to 50% of center illuminance. Recommended spacing is based upon uniform illuminance aiming angle is the angle between the lamp axis and the perpendicular to the illuminated plane.

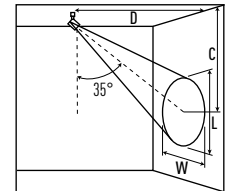
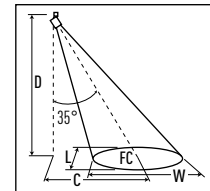
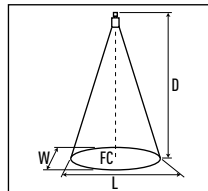

	0° HORIZONTAL				35° HORIZONTAL				35° VERTICAL					
	D	FC	W	L	D	C	FC	W	L	D	C	FC	W	L
MXTG2-RTRR308L3-CR 3000K 12° Spot	6'	600	1.3	1.3	6'	4	341	1.86	1.43	3'	4	666	1.12	1.95
	8'	338	1.8	1.8	8'	5	189	2.54	1.89	4'	5	343	1.43	2.73
	10'	216	2.2	2.2	10'	7	119	3.25	2.77	5'	7	237	1.76	3.25
	12'	150	2.6	2.6	12'	8	85.2	3.78	3.16	6'	8	167	2.22	3.85
MXTG2-RTRR308L3-CR 3000K 24° Narrow Flood	6'	283	2.3	2.3	6'	4	164	3.17	2.76	3'	4	327	1.78	3.09
	8'	159	3.1	3.1	8'	5	95.7	4.05	3.44	4'	5	188	2.48	3.98
	10'	102	3.9	3.9	10'	6	61.5	5.05	4.32	5'	6	118	3.14	4.99
	12'	70.8	4.6	4.6	12'	7	42.2	6.11	5.27	6'	8	81.6	3.7	6.01
MXTG2-RTRR308L3-CR 3000K 36° Flood	6'	144	3.3	3.3	6'	3	91.3	4.02	3.52	3'	4	166	2.72	3.97
	8'	80.8	4.4	4.4	8'	4	51.4	5.34	4.77	4'	5	98.2	3.34	5.09
	10'	51.7	5.5	5.5	10'	5	32.9	6.63	5.87	5'	6	64.1	4.22	6.25
	12'	35.9	6.6	6.6	12'	6	22.8	8	7.09	6'	7	44.8	4.97	7.46
MXTG2-RTRR308L3-CR 3000K 50° Wide Flood	6'	44.4	5.7	5.7	6'	2	32.1	5.16	5.22	3'	3	59.3	3.73	4.54
	8'	25	7.6	7.6	8'	3	18.3	6.73	6.93	4'	4	33.4	4.98	5.97
	10'	16	9.6	9.6	10'	4	11.7	8.43	8.74	5'	5	21.4	6.34	7.49
	12'	11.1	11.5	11.5	12'	5	8.1	10.15	10.57	6'	6	14.8	7.58	8.97